

BEDIENUNGSANWEISUNG

mit Montageanweisungen

INSTRUCTIONS FOR USE

and installation

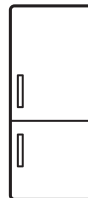

EN

FKG6500.0E



Lesen Sie unbedingt die Gebrauchsanleitung und den Montageplan vor Aufstellung, Installation sowie Inbetriebnahme.

Please read the users and installation instructions carefully before installation of the appliance and before starting to use it.

Service und Kundendienst

Telefon: 0209 – 401 631

Email: kundendienst@kueppersbusch.de

Küppersbusch

FÜR KÜCHEN MIT STIL



Contents

1.	SAFETY WARNINGS.....	1
2.	INSTALLTION.....	3
2.1	Location.....	3
2.2	Door Handle Install Illumination(optional)	3
2.3	Reversing the Door Swing	5
2.4	Door Space Requirements.....	7
2.5	Levelling the Unit	7
2.6	Cleaning Before Use	7
2.7	Before Using Your Unit.....	8
2.8	Interior Accessories.....	8
3.	PRODUCT OVERVIEW	9
4.	OPERATION.....	10
4.1	Operation Instructions	10
4.2	Noise Inside the Unit!.....	11
4.3	Tips for Keeping Food in the Unit.....	11
4.4	Change the Light Bulb	12
5.	CLEANING	12
5.1	Defrosting.....	12
5.2	Cleaning the Interior and the Exterior of the Unit	12
5.3	Cleaning Tips	12
6.	MAINTENANCE	13
6.1	Changing the Internal Light.....	13
6.2	Care When Handling / Moving Your Unit.....	13
6.3	Servicing	13
6.4	Switching Off for Long Periods of Time.....	13
6.5	Do not shield positions of air outlet and return air inlet of the refrigerator	13
7.	Trouble shooting	14
7.1	Warm tips:.....	14
8.	TIPS FOR ENERGY SAVING	14
9.	DISPOSAL	15

1. SAFETY WARNINGS



Warning: risk of fire / flammable materials

This appliance is intended to be used in household and similar applications such as staff kitchen areas in shops, offices and other working environments; farm houses and by clients in hotels, motels and other residential type environments; bed and breakfast type environments; catering and similar non-retail applications.

If the supply cord is damaged, it must be replaced by the manufacturer, its service agent or similarly qualified persons in order to avoid a hazard.

Do not store explosive substances such as aerosol cans with a flammable propellant in this appliance.

The appliance has to be unplugged after use and before carrying out user maintenance on the appliance..

WARNING: Keep ventilation openings, in the appliance enclosure or in the built-in structure, clear of obstruction.

WARNING: Do not use mechanical devices or other means to accelerate the defrosting process, other than those recommended by the manufacturer.

WARNING: Do not damage the refrigerant circuit.

WARNING: Do not use electrical appliances inside the food storage compartments of the appliance, unless they are of the type recommended by the manufacturer.

WARNING: Please abandon the refrigerator according to local regulators for its use flammable blowing gas and refrigerant.

WARNING: When positioning the appliance, ensure the supply cord is not trapped or damaged.

WARNING: Do not locate multiple portable socket-outlets or portable power supplies at the rear of the appliance.

Do not use extension cords or ungrounded (two prong) adapters.

DANGER: Risk of child entrapment. Before you throw away your old refrigerator or freezer:

- Take off the doors.
- Leave the shelves in place so that children may not easily climb inside.

The refrigerator must be disconnected from the source of electrical supply before attempting the installation of accessory.

Refrigerant and cyclopentane foaming material used for the refrigerator are flammable.



Therefore, when the refrigerator is scrapped it shall be kept away from any fire source and be recovered by a special recovering company with corresponding qualification other than be disposed by combustion, so as to prevent damage to the environment or any other harm.

For EN standard: This appliance can be used by children aged from 8 years and above and persons with reduce physical sensory or mental capabilities or lack of experience and knowledge if they have been given supervision or instruction concerning use of the appliance in a safe way and understand the hazards involved. Children shall not play with the appliance. Cleaning and user maintenance shall not be made by children without supervision. Children aged from 3 to 8 years are allowed to load and unload refrigerating appliances.

For IEC standard: This appliance is not intended for use by persons (including children) with reduced physical, sensory or mental capabilities, or lack of experience and knowledge, unless they have been given supervision or instruction concerning use of the appliance by a person responsible for their safety.)

Children should be supervised to ensure that they do not play with the appliance.

The instructions shall include the substance of the following: To avoid contamination of food, please respect the following instructions:

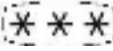
- Opening the door for long periods can cause a significant increase of the temperature in the compartments of the appliance.
- Clean regularly surfaces that can come in contact with food and accessible drainage systems.
- Clean water tanks if they have not been used for 48 h; flush the water system connected to a water supply if water has not been drawn for 5 days. (note 1)
- Store raw meat and fish in suitable containers in the refrigerator, so that it is not in contact with or drip onto other food.
- Two-star  frozen-food compartments are suitable for storing pre-frozen food, storing or making ice-cream and making ice cubes. (note 2)
- One  -,two  -and three-star  compartments are not suitable for the freezing of fresh food. (note 3)
- If the refrigerating appliance is left empty for long periods, switch off, defrost, clean, dry, and leave the door open to prevent mould developing within the appliance.

Note 1,2,3: Please confirm whether it is applicable according to you product compartment type.

2. INSTALLTION

2.1 Location

When selecting a position for your unit you should make sure the floor is flat and firm, and the room is well ventilated. Avoid locating your unit near a heat source, e.g. cooker, boiler or radiator. Also avoid direct sunlight as it may increase the electrical consumption. Extreme cold ambient temperatures may also cause the unit not to perform properly. This unit is not designed for use in a garage or outdoor installation. Do not drape the unit with any covering.

When installing the unit, ensure that 10 cm of free space is left at both sides, 10 cm at the rear and 30 cm at the top of the unit. This will allow cold air to circulate around the wine cooler and improve the efficiency of the cooling process.

2.2 Door Handle Install Illumination(optional)

- 1) Take out the screw caps from the door handle holes.
- 2) Put the handles into the screw holes and then hit them to fix .

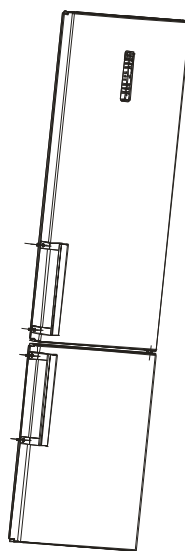
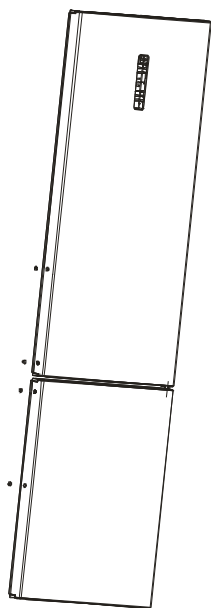

3) Cap the screw caps on the handle screws.

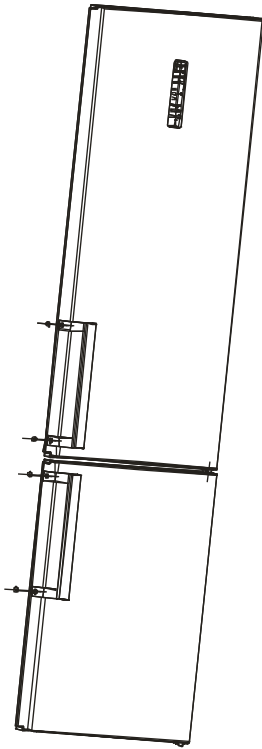

2) Remove the screws and take the handles down.

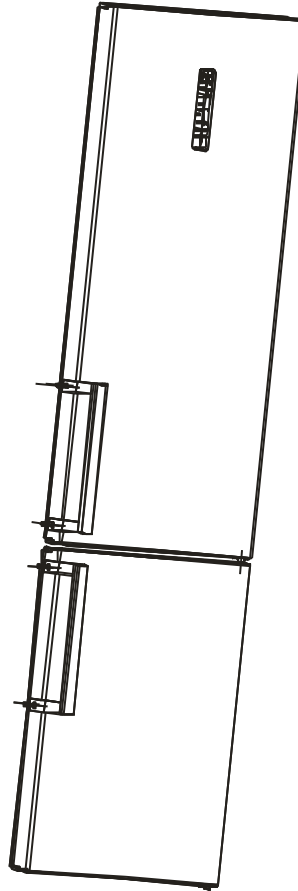

1) Take out the screw caps from the handle screw holes.

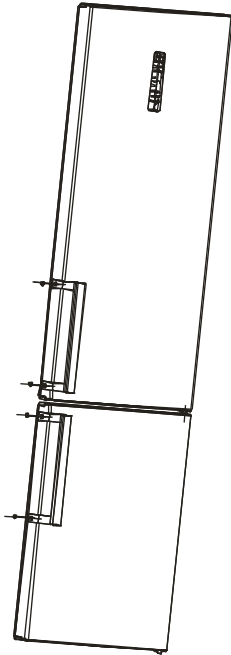

3) Cap the screw caps on the door handle holes again.

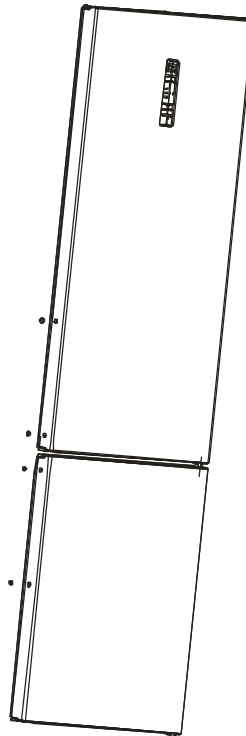

- 4) Install the handles into the door handle holes of the other side in accordance with the handle installation instructions.

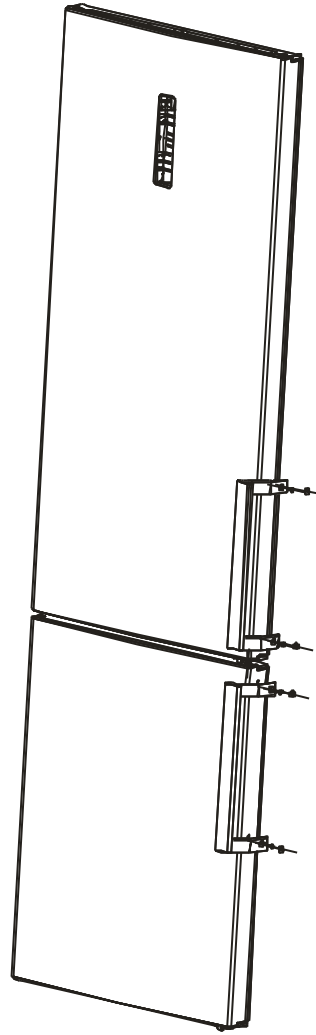

- 2) Take off top hinge.

2.3 Reversing the Door Swing

- 1) Take off knuckle guard.

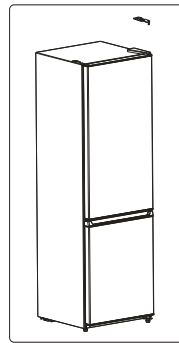
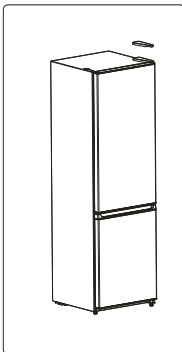

- 3) Take off the door of refrigerating chamber

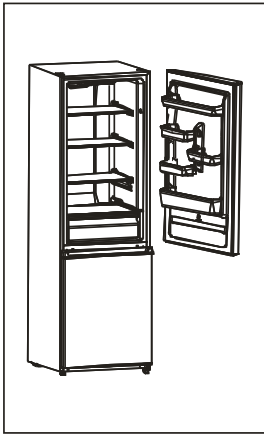

- 4) Take off middle hinge, left middle beam screw cap and screw with a screw driver

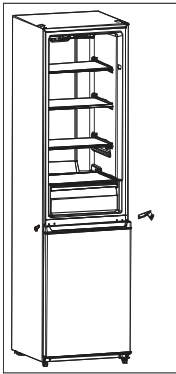

- 5) Take off the door of freezing chamber

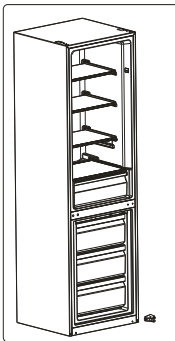

- 6) Take off hinge assembly with a screw driver , Assemble lower hinge assembly to left side of the cabinet with a screw driver. Fix the removed medium beam screw and screw cap to the right screw hole position.

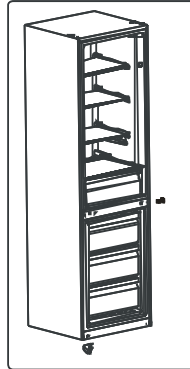

- 7) Assemble the door of freezer chamber on the lower hinge

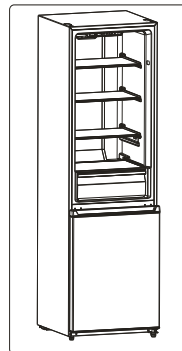

- 8) Assemble middle hinge assembly to left side of the cabinet

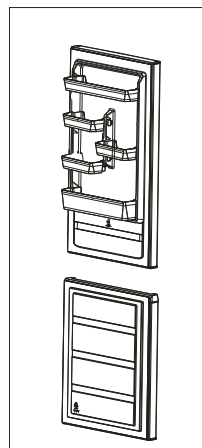

9) Assemble the door of refrigerating

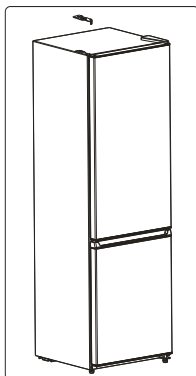

10) Take on knuckle guard.

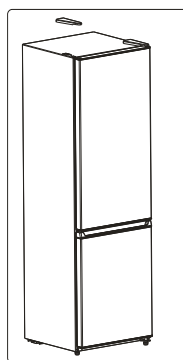

2.4 Door Space Requirements

The unit's door must be able to open fully as shown.

$W \times D \geq 990 \times 1025\text{mm}$

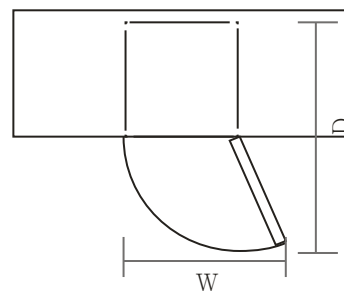

2.5 Levelling the Unit

To do this adjust the two levelling feet at the front of the unit.

If the unit is not level, the door and magnetic seal alignments will not be covered properly.

Make sure that the foot touches the ground before use.

Look down from the top, clockwise and counterclockwise loosening, tightening.

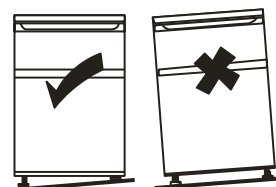

2.6 Cleaning Before Use

Wipe the inside of the unit with a weak solution of bicarbonate soda. Then rinse with warm water using a 'Wrung-out' sponge or cloth. Wash the shelves and salad bin in warm soapy water and dry completely before replacing in the unit. Clean the exterior of the unit with a damp cloth. If you require more information refer to the Cleaning section.

2.7 Before Using Your Unit

The refrigerator adopts 220~240V/50Hz AC power, voltage fluctuations over the range of 187 ~ 264V will cause malfunction or even damage.

Do not damage the power cord under any condition so as to ensure safety use, do not use when the power cord is damaged or the plug is worn.

Do not put flammable, explosive, volatile and highly corrosive items in the refrigerator to prevent damages to the product or fire accidents.

Do not place flammable items near the refrigerator to avoid fires.

This product is household refrigerators and shall be only suitable for the storage of foods. According to national standards, household refrigerators shall not be used for other purposes, such as storage of blood, drugs or biological products.

Do not place items such as bottled or sealed container of fluid such as bottled beers and beverages in the freezer to prevent bursts and other losses.

Before placing any food in your unit, turn it on and wait for 24 hours, to make sure it is working properly and to allow it time to fall to the correct temperature. Your unit should not be overfilled.

Do not damage the power cord under any condition so as to ensure safety use, do not use when the power cord is damaged or the plug is worn.

Do not put flammable, explosive, volatile and highly corrosive items in the refrigerator to prevent damages to the product or fire accidents.

Do not place flammable items near the refrigerator to avoid fires.

This product is household refrigerators and shall be only suitable for the storage of foods. According to national standards, household refrigerators shall not be used for other purposes, such as storage of blood, drugs or biological products.

Do not place items such as bottled or sealed container of fluid such as bottled beers and beverages in the freezer to prevent bursts and other losses.

Before placing any food in your unit, turn it on and wait for 24 hours, to make sure it is working properly and to allow it time to fall to the correct temperature. Your unit should not be overfilled.

Do not store or place dry ice in the refrigerator.



◆ **Before Plugging in**

You must check that you have a socket which is compatible with the plug supplied with the unit.

◆ **Before Turning On!**

Do not turn on until two hours after moving the unit.

2.8 Interior Accessories

Various glass or plastic storage shelves are included with your appliance - different models have different combinations.

You should always slide one of the full size glass storage shelves into the lowest set of guides, above the fruit and vegetable containers, and keep it in this position. To do

this, pull the storage shelf forward until it can be swiveled upwards or downwards and removed.

Please do the same in reverse to insert the shelf at a different height.

 In order to make the most of the volume of the fresh food storage compartment and frozen-food storage compartment, the user can remove one or more shelves, drawers, out of the appliance, according to your daily use.

3. PRODUCT OVERVIEW(optional)

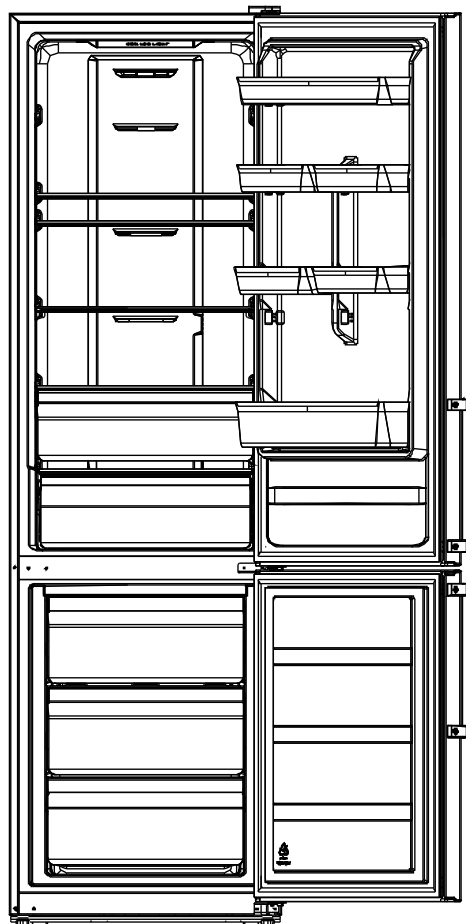

*Dotted line represents the position of air outlet and return air inlet.

*All images in this instruction manual are for indication only; please refer to your individual unit for details.

4. OPERATION

4.1 Operation Instructions

Temperature control

Temperature control of fresh food storage compartment

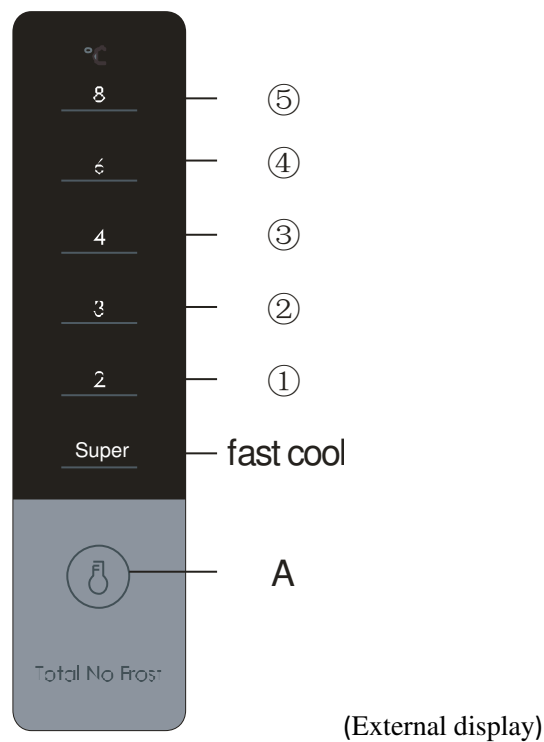
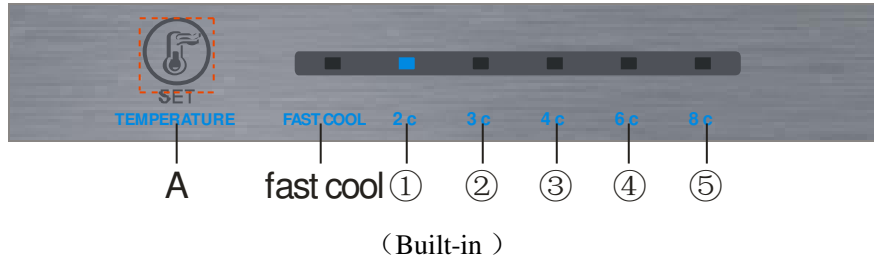

Key

A.SET: gear setting key

Display screen

- 1 Gear 1
- 2 Gear 2
- 3 Gear 3
- 4 Gear 4
- 5 Gear 5

Display

For the first power-on, the display screen (including the key light) will be displayed in full for 3s, and then the gear in the middle displays the state of running

Display of normal running

On the occurrence of a failure, the corresponding LED light will give a combined display of failure

code (loop display);

Where there is no failure, the LED light will display the current running gear of the refrigerator.

Gear setting

The gear will be changed once every time when you press the key SET. Then, the refrigerator will run under the setting value after 15s.

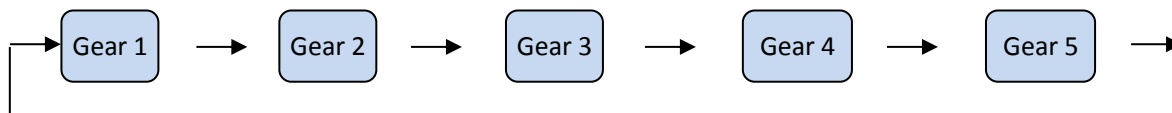

Fast cool function

Enter: Circulating modulation rapid cooling mode

Operate: Indicator of rapid cooling lights up, and the refrigerator operates at 2°C.

Exit: 1. Operate 150min under the rapid cooling mode

2. Temperature adjustment can exit from the rapid cooling mode

◆ Temperature control of freezing chamber

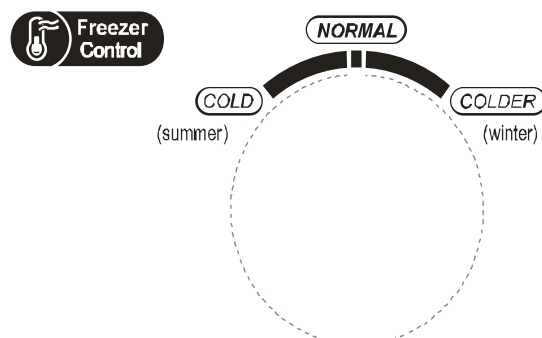

The freezing temperature is relatively low in "COLDER" position, while the freezing temperature is relatively high in "COLD" position, thus, "NORMAL" position is generally used.

When ambient temperature is high in summer, the temperature shall be in the range from "NORMAL" to "COLD". If the ambient temperature is above 35°C, then "COLD" position shall prevail.

When ambient temperature is low in winter, the temperature shall be in the range from "NORMAL" to "COLDER". If the ambient temperature is below 10°C, then "COLDER" position shall prevail.

Chill compartment description: the temperature of chill compartment is $-2 \leq t_{cc} \leq 3$, the maximum tcc should be as near as possible +3°C which however should not be exceeded. The compartment is not suitable for storing certain fresh vegetables and fruits (which are sensitive to low temperature).

4.2 Noise Inside the Unit!

You may notice that your unit makes some unusual noises. Most of these are perfectly normal, but you should be aware of them!

These noises are caused by the circulation of the refrigerant liquid in the cooling system. It has become more pronounced since the introduction of CFC free gases. This is not a fault and will not affect the performance of your unit. This is the compressor motor working, as it pumps the refrigerant around the system.

4.3 Tips for Keeping Food in the Unit

- ◆ Cooked meats/fishes should always be stored on a shelf above raw meats/fishes to avoid bacterial transfer. Keep raw meats/fishes in a container which is large enough to collect juices and cover it properly. Place the container on the lowest shelf.
- ◆ Leave space around your food, to allow air to circulate inside the unit. Ensure all parts of the unit are kept cool.
- ◆ To prevent transfer of favours and drying out, pack or cover the food separately. Fruit and vegetables do not need to be wrapped.
- ◆ Always let pre-cooked food cool down before you put in the unit. This will help to maintain the internal temperature of the unit.
- ◆ To prevent cold air escaping from the unit, try to limit the number of times you open the door. We recommend that you only open the door when you need to put food in or take food out.

4.4 Change the Light Bulb

Lamp replacement by professionals

5. CLEANING

5.1 Defrosting

Auto-defrost for Frost-free Refrigerator

5.2 Cleaning the Interior and the Exterior of the Unit

- ◆ Dusts behind the refrigerator and on the ground shall be timely cleaned to improve the cooling effect and energy saving.
- ◆ Check the door gasket regularly to make sure there are no debris. Clean the door gasket with a soft cloth dampened with soapy water or diluted detergent.
- ◆ The interior of the refrigerator should be cleaned regularly to avoid odor.
- ◆ Please turn off the power before cleaning interior, remove all foods, drinks ,shelves, drawers, etc.
- ◆ Use a soft cloth or sponge to clean the inside of the refrigerator, with two tablespoons of baking soda and a quart of warm water. Then rinse with water and wipe clean. After cleaning, open the door and let it dry naturally before turning on the power.
- ◆ For areas that are difficult to clean in the refrigerator (such as narrow sandwiches, gaps or corners), it is recommended to wipe them regularly with a soft rag, soft brush, etc. and when necessary, combined with some auxiliary tools (such as thin sticks) to ensure no contaminants or bacteria accumulation in these areas.
- ◆ Do not use soap, detergent, scrub powder, spray cleaner, etc., as these may cause odors in the interior of the refrigerator or contaminated food.
- ◆ Clean the bottle frame, shelves and drawers with a soft cloth dampened with soapy water or diluted detergent. Dry with a soft cloth or dry naturally.
- ◆ Wipe the outer surface of the refrigerator with a soft cloth dampened with soapy water, detergent, etc., and then wipe dry.
- ◆ Do not use hard brushes, clean steel balls, wire brushes, abrasives(such as toothpastes),

organic solvents (such as alcohol, acetone, banana oil, etc.), boiling water, acid or alkaline items, which may damage the fridge surface and interior. Boiling water and organic solvents such as benzene may deform or damage plastic parts.

- ◆ Do not rinse directly with water or other liquids during cleaning to avoid short circuits or affect electrical insulation after immersion.

5.3 Cleaning Tips

Condensation may appear on the outside of the unit. This may be due to a change in room temperature. Wipe of any moisture residue. If the problem continues, please contact a qualified technician for assistance.

6. MAINTENANCE

6.1 Changing the Internal Light

Lamp replacement by professionals.

6.2 Care When Handling / Moving Your Unit

Hold the unit around its sides or base when moving it. Under no circumstances should it be lifted by holding the edges of the top surface.

6.3 Servicing

The unit should be serviced by an authorized engineer and only genuine spare parts should be used. Under no circumstances should you attempt to repair the unit yourself. Repairs carried out by inexperienced persons may cause injury or serious malfunction. Contact a qualitatively technician.

6.4 Switching Off for Long Periods of Time

When the unit is not in use for a long period of time, disconnect it from the mains supply, empty all food and clean the appliance, leaving the door ajar to prevent unpleasant smells.

6.5 Do not shield positions of air outlet and return air inlet of the refrigerator

6.6 Do not keep foods of higher temperature close to temperature sensor

6.7 Take out drawer of freezing chamber of refrigerator and put foods directly on the glass partition

7. Trouble shooting

The following simple issues can be handled by the user. Please call the after-sale service department if the issues are not settled.

Inoperation	Whether the freezer is plugged and connected to power; Low voltage; Failure power or tripping circuit
Odor	Odorous foods should closely wrapped; Whether foods are rotten; Whether the interior shall be cleaned.
Long-term operation of compressor	It is normal that refrigerator operates for longer time in summer when the ambient temperature is higher; Do not put too much food in the freezer at one time; Do not put foods until they are cooled; Frequent opening of refrigerator door.
Illuminating light does not shine	Whether the refrigerator is connected to power, whether the illuminating light is damaged.
The refrigerator door can not be properly closed.	The freezer door is stuck by food packages; Too much food; Tilt refrigerator.
Loud noises	Whether the food is leveled, whether the refrigerator is balanced; Whether the refrigerator parts are properly placed.

7.1 Warm tips:

- ◆The refrigerator enclosure may emit heat during operation specially in summer, this is caused by the radiation of the condenser, and it is a normal phenomenon.
- ◆Condensation: condensation phenomenon will be detected on the exterior surface and door seals of the freezer when the ambient humidity is large, this is a normal phenomenon, and the condensation can be wiped away with a dry towel.
- ◆Buzz: Buzz will be generated by running compressor specially when starting up or shutting down.

8. TIPS FOR ENERGY SAVING

Try not to open the door too often, especially when the weather is wet and hot. Once you open the door, close it as soon as possible.

Every now and then check if the appliance is sufficiently ventilated (adequate air circulation behind the appliance).

In normal temperature conditions, please arrange the thermostat at the middle setting.

Before loading the appliance with packages of fresh food, make sure they are cooled to ambient temperature.

Ice and frost layer increase energy consumption, so clean the appliance as soon as the layer is 3-5 mm thick.

If it is the outer condenser, the rear wall should be always clean free of dust or any impurities.

- ◆ The appliance should be located in the coolest area of the room, away from heat producing appliances or heating ducts, and out of the direct sunlight.
- ◆ Let hot foods cool to room temperature before placing in the appliance. Overloading the appliance forces the compressor to run longer. Foods that freeze too slowly may lose quality, or spoil.
- ◆ Be sure to wrap foods properly, and wipe containers dry before placing them in the appliance. This cuts down on frost build-up inside the appliance.
- ◆ Appliance storage bin should not be lined with aluminum foil, wax paper, or paper toweling. Liners interfere with cold air circulation, making the appliance less efficient.
- ◆ Organize and label food to reduce door openings and extended searches. Remove as many items as needed at one time, and close the door as soon as possible.

9. DISPOSAL

Old units still have some residual value. An environmentally friendly method of disposal will ensure that valuable raw materials can be recovered and used again. The refrigerant used in your unit and insulation materials require special disposal procedures. Ensure that none of the pipes on the back of the unit are damaged prior to disposal. Up to date information concerning options of disposing of your old unit and packaging from the new one can be obtained from your local council office.

When disposing of an old unit break of any old locks or latches and remove the door as a safeguard.

Correct Disposal of this product	
	<p>Correct Disposal of this product</p> <p>This marking indicates that this product should not be disposed with other household wastes throughout the EU. To prevent possible harm to the environment or human health from uncontrolled waste disposal, recycle it responsibly to promote the sustainable reuse of material resources. To return your used device, please use the return and collection systems or contact the retailer where the product was purchased. They can take this product for environmental safe recycling.</p>

For more information, please contact the local authority or your retailer where you purchased the product.

Küppersbusch

Küppersbusch Hausgeräte GmbH

Postfach 10 01 32, D-45801 Gelsenkirchen,
Küppersbuschstraße 2, D-45883 Gelsenkirchen
Telefon: (0209) 401-0, Telefax: (0209) 401-303
www.kueppersbusch-home.com

