

DF

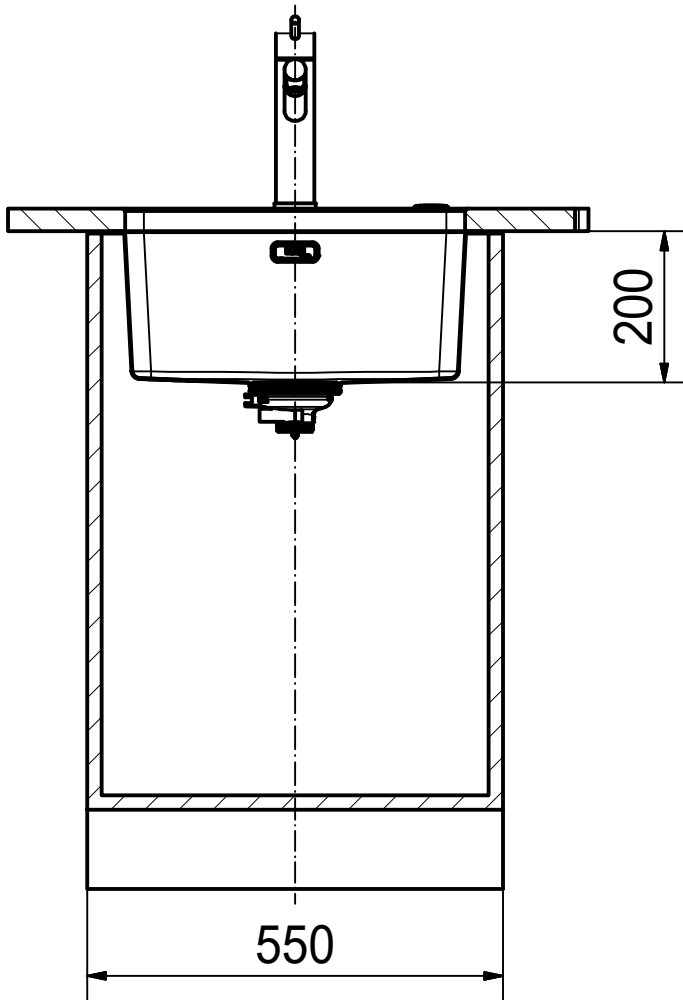

Drawing No.	20140286_01	Revision	-
Drawn Date	06.06.2019		
<small>These drawings and specifications are the property of Franke Technology and Trademark Ltd. and shall not be reproduced, copied or transferred to any third party without the prior written permission of Franke Technology and Trademark Ltd., Hergiswil, Switzerland</small>			



MYX 110-45 I
installing document

Sheet	Sheets
1	6

DS

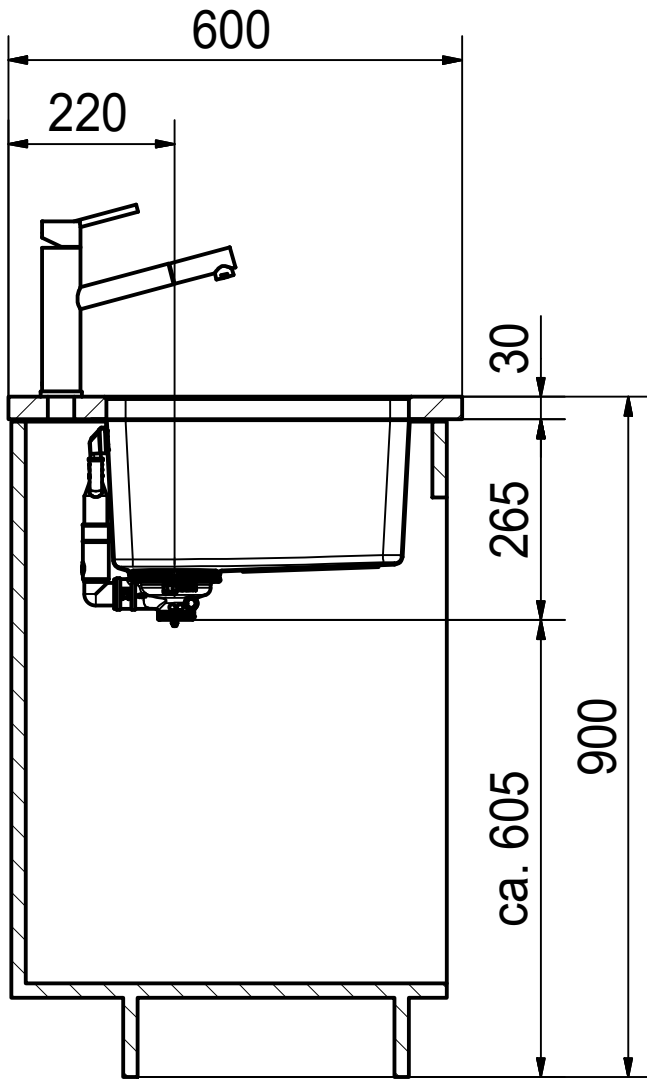

Drawing No.	20140286_01	Revision	-
Drawn Date	06.06.2019		
<small>These drawings and specifications are the property of Franke Technology and Trademark Ltd. and shall not be reproduced, copied or transferred to any third party without the prior written permission of Franke Technology and Trademark Ltd., Hergiswil, Switzerland</small>			



MYX 110-45 I
installing document

Sheet	Sheets
2	6

CO

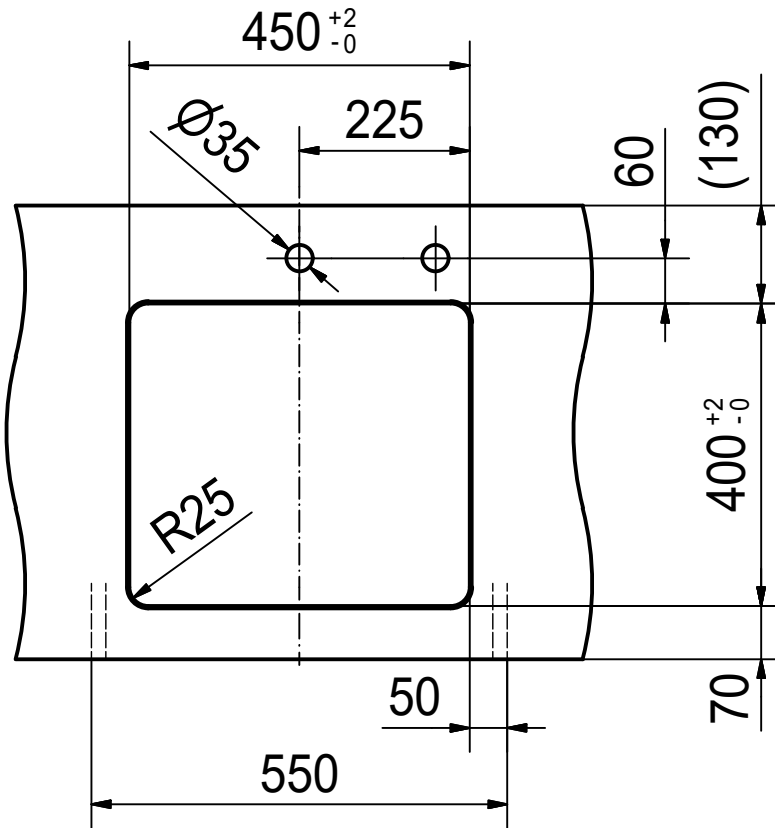

Drawing No.	20140286_01	Revision	-
Drawn Date	06.06.2019		
<small>These drawings and specifications are the property of Franke Technology and Trademark Ltd. and shall not be reproduced, copied or transferred to any third party without the prior written permission of Franke Technology and Trademark Ltd., Hergiswil, Switzerland</small>			



MYX 110-45 I
installing document

Sheet	Sheets
3	6

CNC



Drawing No.	20140286_01	Revision	-
Drawn Date	06.06.2019		
<small>These drawings and specifications are the property of Franke Technology and Trademark Ltd. and shall not be reproduced, copied or transferred to any third party without the prior written permission of Franke Technology and Trademark Ltd., Hergiswil, Switzerland</small>			



MYX 110-45 I
installing document

Sheet	Sheets
4	6

DT

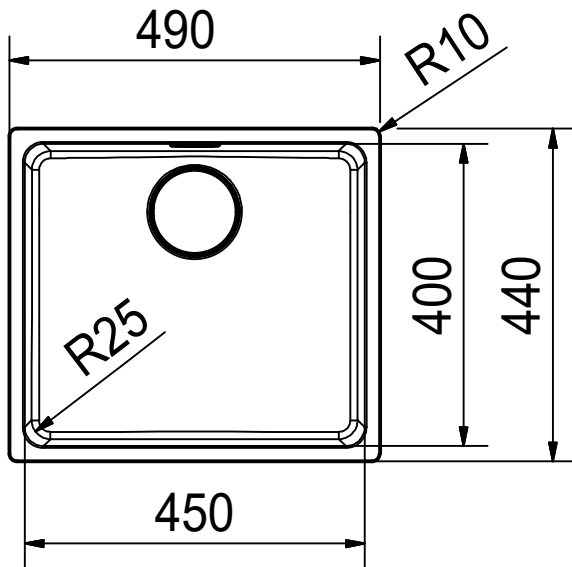

Drawing No.	20140286_01	Revision	-
Drawn Date	06.06.2019		
<small>These drawings and specifications are the property of Franke Technology and Trademark Ltd. and shall not be reproduced, copied or transferred to any third party without the prior written permission of Franke Technology and Trademark Ltd., Hergiswil, Switzerland</small>			



MYX 110-45 I
installing document

Sheet	Sheets
5	6

ISO

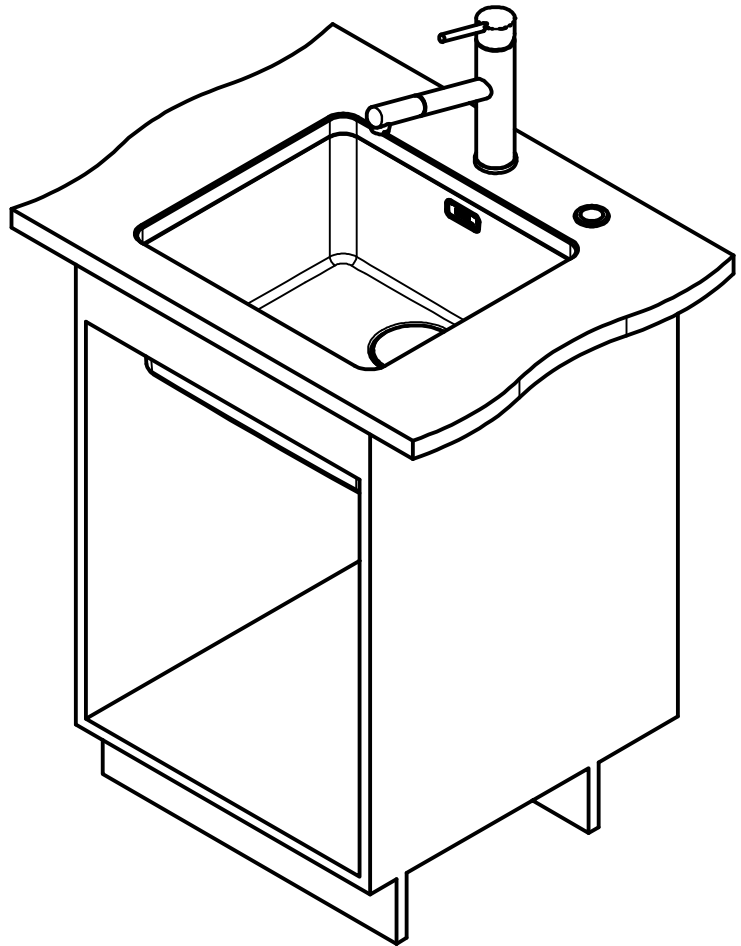

Drawing No.	20140286_01	Revision	-
Drawn Date	06.06.2019		
<small>These drawings and specifications are the property of Franke Technology and Trademark Ltd. and shall not be reproduced, copied or transferred to any third party without the prior written permission of Franke Technology and Trademark Ltd., Hergiswil, Switzerland</small>			



MYX 110-45 I
installing document

Sheet	Sheets
6	6