

7081 179-00

WKEes 1009

Disposal notes

- **Keep packaging materials away from children - polythene sheets and bags can cause suffocation!**
- Please return the packaging to an official collection point.

Your old appliance: This contains some reusable materials and should be disposed of properly - not simply with unsorted household refuse.

- Discarded appliances should be disabled: Remove the plug, cut through the connection cable and render the catch unusable so that children cannot become trapped inside.
- Ensure that the refrigerant circuit is not damaged when the appliance that is no longer needed is taken away for disposal.
- Details of the refrigerant can be found on the type plate.
- Appliances which are no longer needed must be disposed of in a professional and appropriate way, in accordance with the current local regulations and laws.



Range of appliance use

The appliance is suited only for storing wine. In the case of commercial food cooling, the pertinent statutory regulations have to be observed.

The appliance is not suited for storing and cooling pharmaceuticals, blood plasma, laboratory preparations or similar substances and products subject to the Medical Devices Directive 2007/47/EC.

Any misuse of the appliance may result in damage to or spoilage of the stored goods.

Furthermore, the appliance is unsuited for use in areas exposed to an explosion hazard.

Climate rating

The appliance is set to operate within specific ambient temperature limits according to its climate rating. These temperature limits should not be exceeded. The correct climate rating for your appliance is indicated on the type plate.

Climate rating	Ambient temperature
SN	+10°C to +32°C
N	+16°C to +32°C
ST	+16°C to +38°C
T	+16°C to +43°C

Description of appliance and equipment

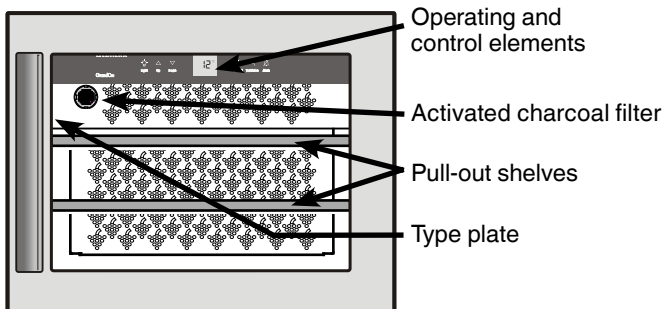

Safety instructions and warnings

- To prevent injury or damage to the unit, the appliance should be unpacked and set up by two people.
- In the event that the appliance is damaged on delivery, contact the supplier immediately before connecting to the mains.
- To guarantee safe operation, ensure that the appliance is set up and connected as described in these operating instructions.
- Disconnect the appliance from the mains if any fault occurs. Pull out the plug, switch off or remove the fuse.
- When disconnecting the appliance, pull on the plug, not on the cable.
- Any repairs and work on the appliance should only be carried out by the customer service department, as unauthorised work could prove highly dangerous for the user. The same applies to changing the mains power cable.
- Do not allow naked flames or ignition sources to enter the appliance. When transporting and cleaning the appliance ensure that the refrigerant circuit is not damaged. In the event of damage, make sure that there are no ignition sources nearby and keep the room well ventilated.
- Do not stand on the plinth, drawers or doors or use them to support anything else.
- This appliance is not intended for use by persons (including children) with reduced physical, sensory or mental capabilities or lack of experience and knowledge unless they have been given initial supervision or instruction concerning use of the appliance by a person responsible for their safety. Children should be supervised to ensure that they do not play with the appliance.
- Avoid prolonged skin contact with cold surfaces or chilled/frozen food. This could cause pain, numbness and frostbite. In the case of prolonged skin contact, protective measures should be taken, e.g. gloves should be worn.
- Do not consume food which has been stored for too long, as it could cause food poisoning.
- Do not store explosives or sprays using combustible propellants such as butane, propane, pentane etc. in the appliance. Electrical components might cause leaking gas to ignite. You may identify such sprays by the printed contents or a flame symbol.
- Do not use electrical appliances inside the appliance.
- If you have a lockable appliance, do not keep the key near the appliance or within reach of children.

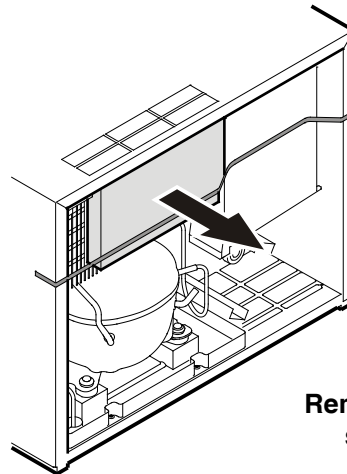

IMPORTANT!
Remove all transportation safety components.

Installation dimensions (mm)

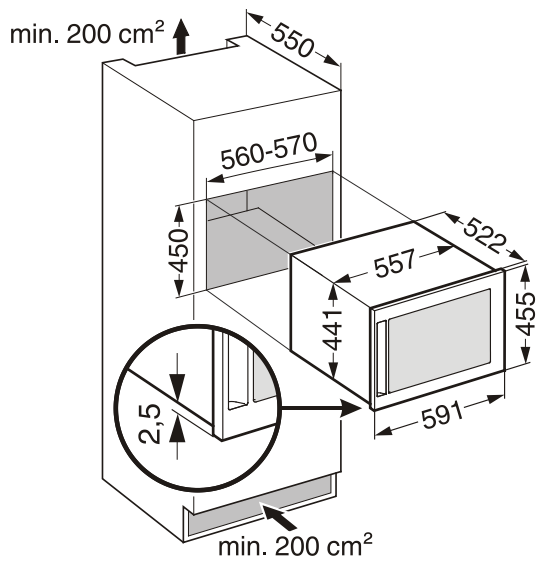

Changing over door hinges

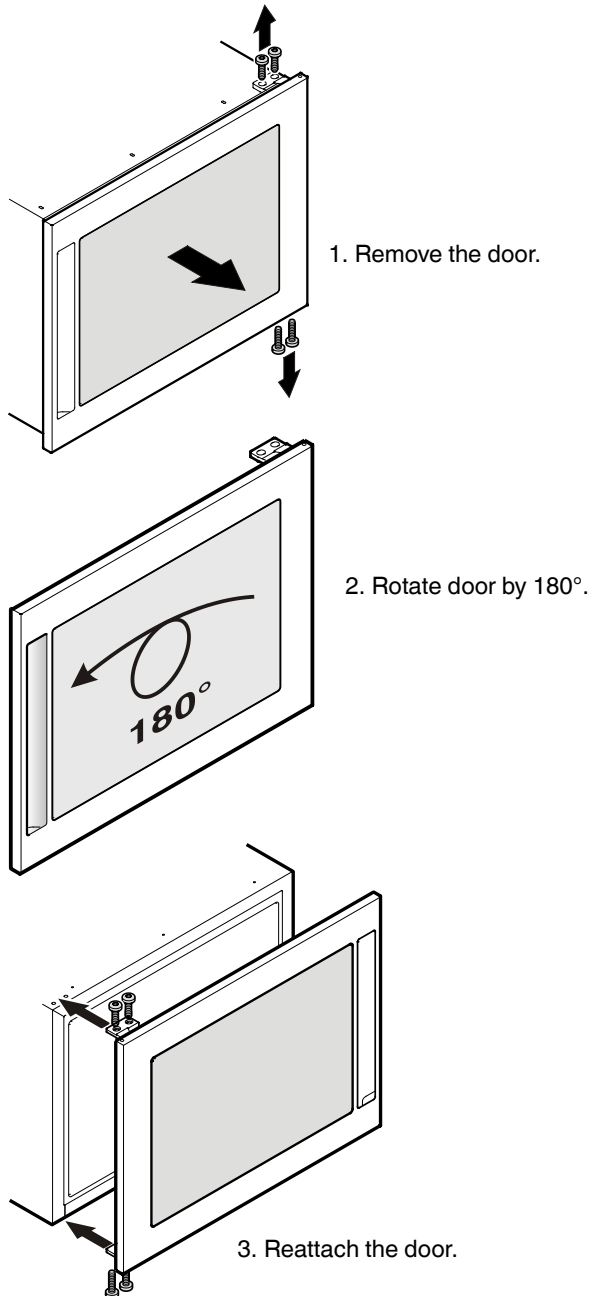

Installing in a kitchen unit

1. Secure the stop bracket in the recess with screws.
2. Connect the appliance to the mains.

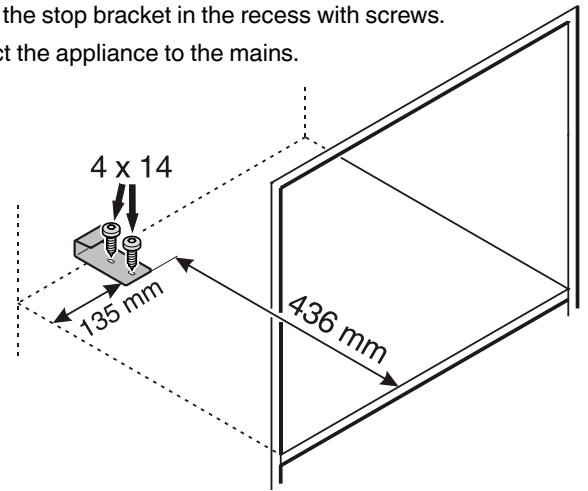

3. Before installing in a kitchen unit, screw the attachment plate provided onto the appliance with screws M4 x 8.

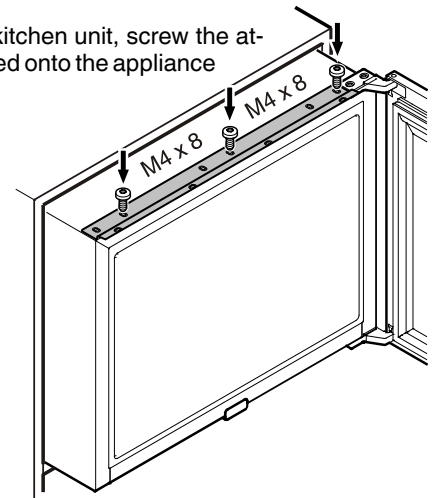

4. Slide the appliance into the recess leaving a 21 mm gap between the body of the unit and the front face of the door.

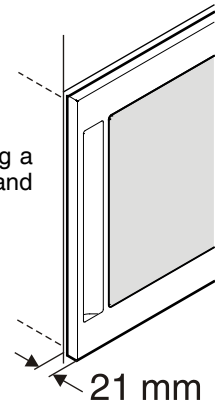

5. Then secure the appliance with 3.5 x 17 chip-board screws through the top bracket.

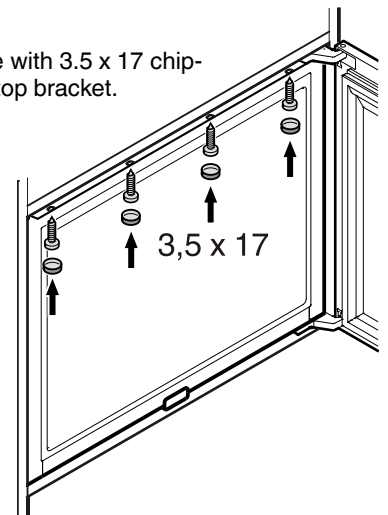

Setting up

- Standard EN 378 specifies that the room in which you install your appliance must have a volume of 1 m³ per 8 g of R 600a refrigerant used in the appliance, so as to avoid the formation of inflammable gas/air mixtures in the room where the appliance is located in the event of a leak in the refrigerant circuit. The quantity of refrigerant used in your appliance is indicated on the type plate on the inside of the appliance.
- Do not connect the appliance to the supply with other equipment using an extension cable - risk of overheating.

Connecting to the mains

Power supply (AC) and voltage at the operating point must comply with the details on the type plate, which is located inside the appliance on the left-hand side. The socket must be fused with a 10 A fuse or higher, it must be away from the rear of the appliance and must be easily accessible.

Connect the appliance with a properly earthed fused plug and socket only.

The wires in the mains lead are coloured in accordance with the following code: green/yellow = earth, blue = neutral, brown = live.

Warning! This appliance must be earthed.

Operating and control elements

The electronic control panel has the new "touch capacitance technology". Any function can be activated by touching the corresponding icon.

The exact contact point is between the symbol and its label  On/Off

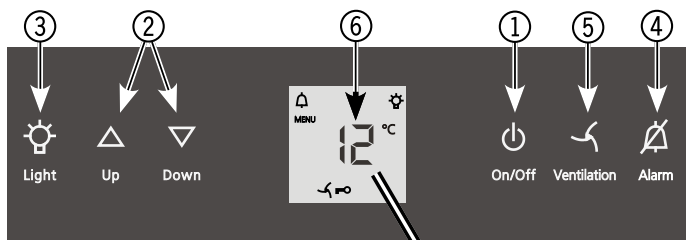

Operating elements

- Appliance ON/OFF
- Temperature setting buttons
- Interior light ON/OFF
- Mute alarm
- Fan ON/OFF
- Temperature display

Control elements

- Interior light ON symbol
- Alarm symbol
- Child lock activated symbol
- Fan ON symbol

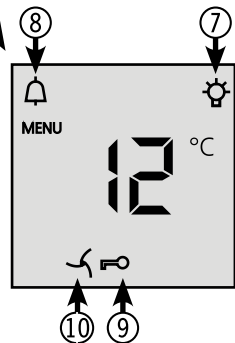

Switching the appliance on or off

Switching on: Press the On/Off button so that the temperature display lights up/flashes.

Switching off: Press the On/Off button for approx. 3 seconds so that the temperature display goes out.

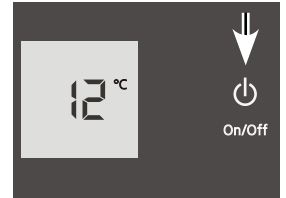

Setting the temperature

To reduce the temperature: Press the Down button.

To increase the temperature: Press the Up button.

- While you are entering the temperature, the set temperature will flash on the display.

- You can change the settings in increments of 1°C briefly pressing the button again.

- The electronic controls will switch over automatically about 5 seconds after the last time you pressed the button, and the actual temperature will be displayed.

The temperature can be set at between +5°C and +20°C.

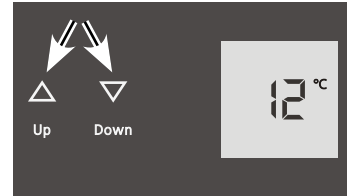

Fan switch

Thereby a climate which corresponds to that of a wine cellar is achieved inside the appliance. Corks are prevented from drying out due to an increased level of humidity.

Switching on: Press the Ventilation button. The fan symbol will light up.

Switching off: Press the Ventilation button again. The fan symbol will go out.

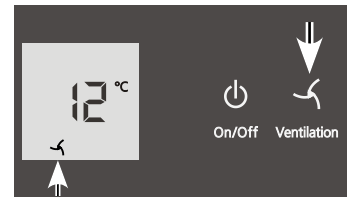

Audible warning signal

The audible warning signal helps to protect your wines against excessive temperatures.

It sounds when the door has been left open for longer than 60 seconds.

It sounds when the interior gets too warm or too cold. The temperature display will also flash. The  symbol lights up.

The audible warning device is switched off by pressing the **Alarm** button.

The temperature display will continue to flash until the cause of the alarm has been rectified.

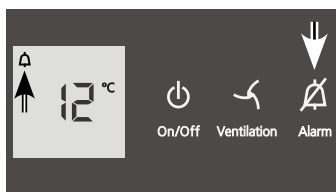

Interior light

The interior light is fitted on the inside at the top.

The interior light can be switched on and off using the **Light** button.

The  symbol lights up when the light is switched on.

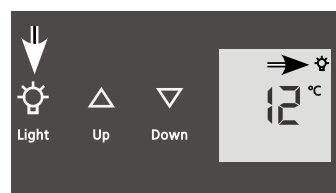

Caution - class 1M laser radiation. When cover is removed, do not look directly at light through optical instruments.

The lighting may only be replaced by the customer service technician or by competent skilled personnel!



Furthermore, the brightness of the lighting can be adjusted.

Press and hold the **Light** button and at the same time press the temperature setting buttons to increase or decrease the brightness.

Down = darker , **Up** = brighter

Setup mode







The following functions can be activated in setup mode:

 = child lock,  = display brightness







= Child lock

The child lock is designed to protect the appliance from being switched off accidentally.

Activating the child lock











- Activate setup mode by pressing the  button for 5 seconds.
- The display reads .
- Press the  button.
- The display reads .
- Press the  button again.
- The  symbol will light up to indicate that the child lock is activated.
- Exit setup mode by pressing the  button.

Deactivating the child lock

- Activate setup mode by pressing the  button for 5 seconds.
- The display reads .
- Press the  button.
- The display reads .
- Press the  button again.
- The  symbol will go out, indicating that the child lock is deactivated.
- Exit setup mode by pressing the  button.

= Display brightness

Adjusting the display brightness

- Activate setup mode by pressing the  button for 5 seconds.
- Press the  button until  appears in the display.
- Press the  button.
- The display reads .
- Press the   buttons and set the brightness between
-  = minimum and
-  = maximum.
- When you reach the desired level, press the  button.
- Exit setup mode by pressing the  button.
- Close the door. The new setting will activate after about 1 minute.

Storing wine

If you are storing wine for long periods of time, it should be stored at a temperature of between 10°C and 14°C.

This is the temperature wine cellars are kept at, and it is just right to allow wine to mature properly.

The following drinking temperatures are recommended for the various types of wine.

Red wines: **+14°C to +18°C**

Rosé wines: **+10°C to +12°C**

White wines: **+8°C to +12°C**

Sparkling wines, Prosecco: **+7°C to +9°C**

Champagne: **+5°C to +7°C**

Storage diagram

(for 750 ml Bordeaux bottles)

Total: 18 bottles

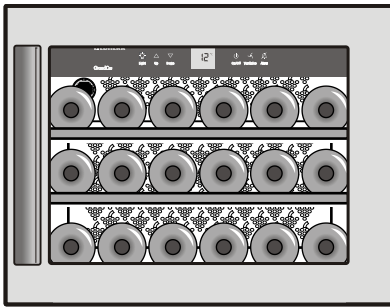

Air exchange with activated charcoal filter

The way in which wines continue to mature depends on the ambient conditions. The quality of the air is therefore decisive for preserving the wine. We recommend that you replace the illustrated filter once a year. Filters can be obtained from your dealer.

Changing the filter:

Take the filter by the handle. Turn it 90° to the left or right and remove.

Inserting the filter:

Insert with the handle in a vertical position. Turn it 90° to the left or right until it clicks into place.

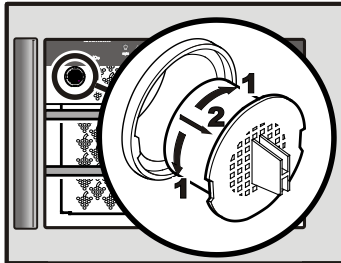

Equipment

Pull-out grid shelves

The pull-out grid shelf allows bottles of wine to be removed more easily.

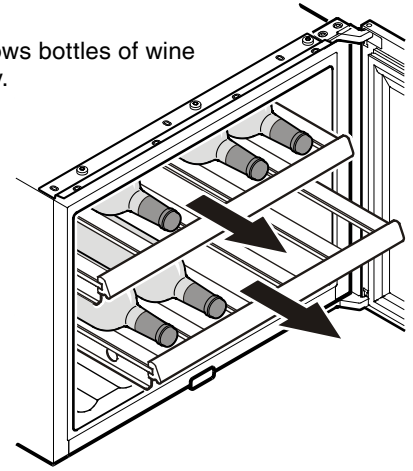

Tall wine bottles can also be stored crossways on the wooden shelves.

To ensure stable storage of the bottles, click the retaining plates provided onto the middle slat of the wooden shelf.

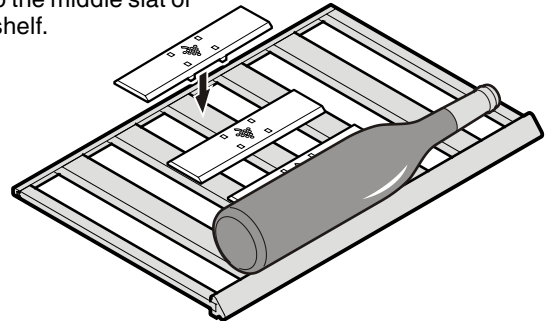

CAUTION!

Do not store bottles crossways on the interior floor! Otherwise, bottles may fall out when the appliance door is opened and this may cause injury or material damage.

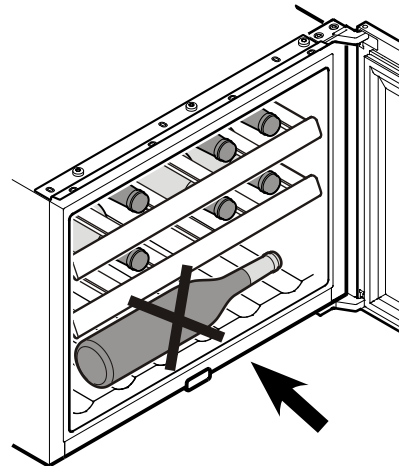

Defrosting

The appliance defrosts automatically. The water that forms on the rear wall drains into a reservoir at the back of the appliance and evaporates automatically through the compressor heat.

Cleaning

Before cleaning always switch off the appliance. Pull out the mains plug or switch off or unscrew the fuse.

- Clean the inside, equipment and outer walls with lukewarm water and a little detergent. Do not use abrasive or acid cleaners or chemical solvents.

Do not use steam cleaners because of the risk of injury and damage.

- Ensure that no cleaning water penetrates into the electrical components or ventilation grille.
- The dust should be removed from the refrigeration unit and heat exchanger - metal grid at the back of the appliance - once a year.
- Do not damage or remove the type plate on the inside of the appliance. It is very important for servicing purposes.

Malfunctions

You may be able to rectify the following faults by checking the possible causes yourself:

- Appliance does not function:
 - Is the appliance switched on?
 - Is the plug correctly fitted in the mains socket?
 - Is the fuse intact?
- Loud running noise:
 - Is the appliance set up firmly on the floor?
 - Does the appliance cause nearby items of furniture or objects to vibrate? Please note that noises caused by the refrigerant circuit cannot be avoided.
- The temperature is not low enough:
 - Is the temperature setting correct (see "Setting the temperature")?
 - Does the separately installed thermometer show the correct reading?
 - Is the ventilation system working properly?
 - Is the appliance set up too close to a heat source?

If none of the above causes apply and you cannot rectify the fault yourself, contact the nearest customer service department stating the type designation ❶, service number ❷ and appliance number ❸ as indicated on the type plate. The type plate is located inside the appliance on the left-hand side.

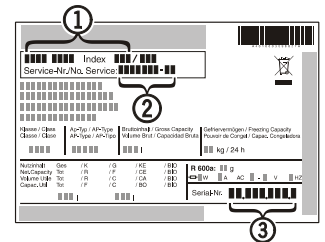

Shutting your appliance down

If your appliance is to be shut down for any length of time, switch it off and disconnect the plug or switch off or unscrew the fuse. Clean the appliance and leave the door open in order to prevent unpleasant smells.

The appliance complies with the relevant safety regulations and EC Directives 2004/108/EC and 2006/95/EC.