

# QUASAR vetro

## Caratteristiche generali



Acciaio inox spazzolato. Filtro antigrasso metallico, asportabile e lavabile. Filtro carbone. Pulsantiera ottica. Finitura vetro temperato: color antracite, bianco, nero.



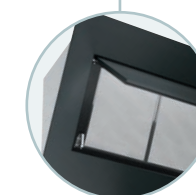
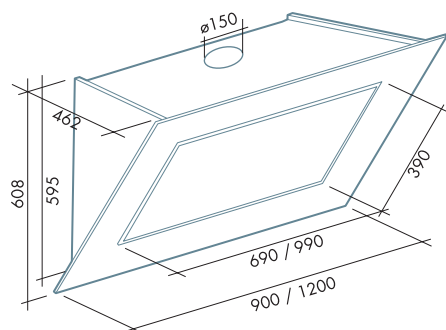

## General features

Scotch brite Stainless steel. Metallic grease filter, removable and washable. Charcoal filter. Soft touch electronic control. Finishing tempered glass: dark grey, white, black.



Pannello fonoassorbente apribile ed asportabile  
Opening and removable noise reduction panel

	isola/island
	/
	/
	/
	parete/wall
	/
	90
	120

motore e comandi / motor and control			filtri / filters			illuminazione / lighting				
450 m <sup>3</sup> /h <u>3 vel.</u>	600 m <sup>3</sup> /h <u>3 vel.</u>	800 m <sup>3</sup> /h <u>4 vel.</u>	"Base"	"Design"	carbone/charcoal	 Halogen lamp	 Dicroica lamp	 Incandescent lamp	 Fluorescent lamp	
		P. OTTICA *	289 x 326 mm		6	3 x 20 Watt				
		P. OTTICA *	289 x 326 mm		6	3 x 20 Watt				

ACCESSORI OPZIONALI DISPONIBILI: Aspiratore sottotetto - Aspiratore esterno - Prolunga camino parete  
AVAILABLE OPTIONAL ACCESSORIES: Under-roof extractor fan - Outdoor extractor fan - Wall chimney extension

\* Pulsantiera ottica  
\* Soft touch electronic control

• Camino opzionale su richiesta  
• s/s chimney available on demand

# QUASAR vetro

Design

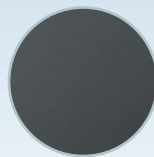
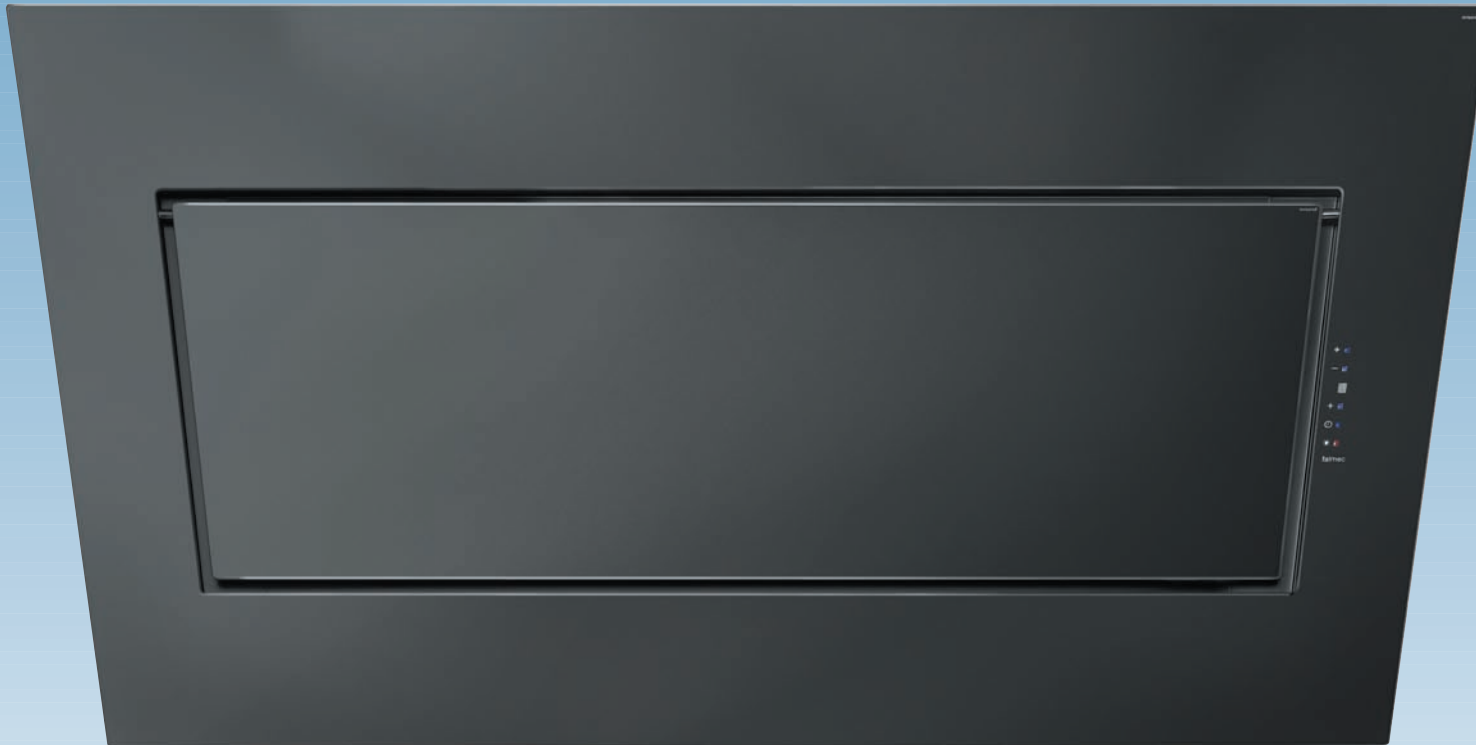

Finitura: antracite  
Finishing: dark grey

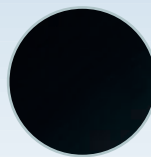

Finitura: nero  
Finishing: black



Finitura: bianco  
Finishing: white