



Quadro Vino

Design e tecnologia si fondono per dar vita al primo quadro refrigerato mai realizzato al mondo. Un oggetto assolutamente innovativo, dal design raffinato, capace di rendere speciale ogni ambiente in cui è inserito.

Design and technology combined to create the first refrigerated frame in the world. A greatly innovative article with sophisticated design that will make any location special.

Design et technologie ensemble pour créer le premier cadre réfrigéré jamais réalisé dans le monde. Un objet absolument innovant, design sophistiqué, capable de rendre spécial tout environnement dans lequel il est inséré.



Quadro Vino

QV40. Struttura bianca, pannello HPL bianco, cornice in colore RAL5012 (light blue).

QV40. White structure, white HPL panel, frame in RAL5012 finish (light blue).

QV40 avec structure blanche, panneau en HPL blanc, cadre en couleur RAL5012 (bleu clair).

I modelli

Models • Modèles



QV12



QV30



QV40



QV52

COLORS

CORNICI • FRAMES • CADRES



PANNELLI • PANELS • PANNEAUX

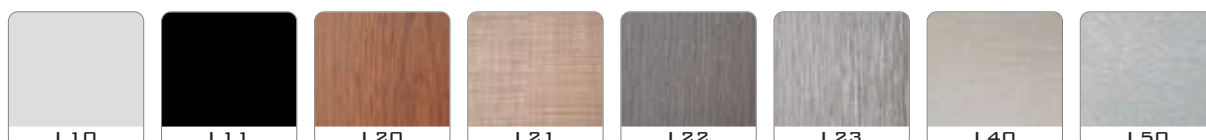



Quadro Vino n. 12

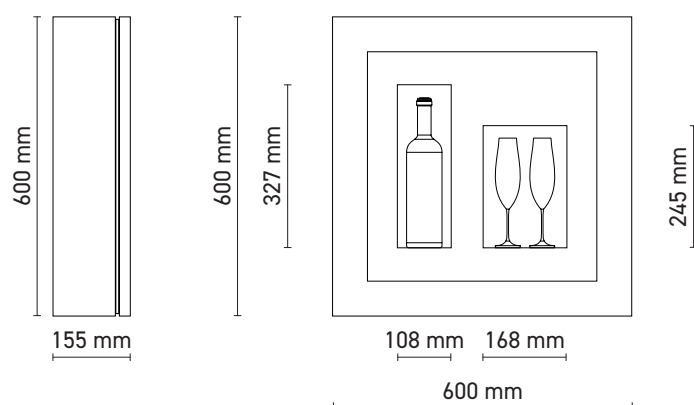

+ 4 / +10

Il QV12 è un espositore refrigerato per una bottiglia e due bicchieri.

La minima profondità e l'installazione a parete ne consentono l'inserimento anche in spazi molto ridotti. È un oggetto studiato principalmente per la camera hotel ma straordinario in qualsiasi ambiente.

Un'atmosfera unica e nuova che invita ad un brindisi veramente speciale.

QV12 is a refrigerated display for one bottle and two glasses.

Its reduced depth and wall installation make it suited even for small spaces.

It is mainly designed for hotel rooms but extraordinary in any setting.

A unique and new atmosphere that really calls for a very special toast.

Le QV12 est un présentoir réfrigéré pour une bouteille et deux verres.

La profondeur réduite et la pose murale permettent de l'installer dans des lieux très réduits. Il est un objet conçu principalement pour la chambre d'hôtel, mais extraordinaire dans toutes les ambiances.

Une atmosphère nouvelle et unique qui vous invite à porter un toast très spécial.



Quadro Vino n. 30

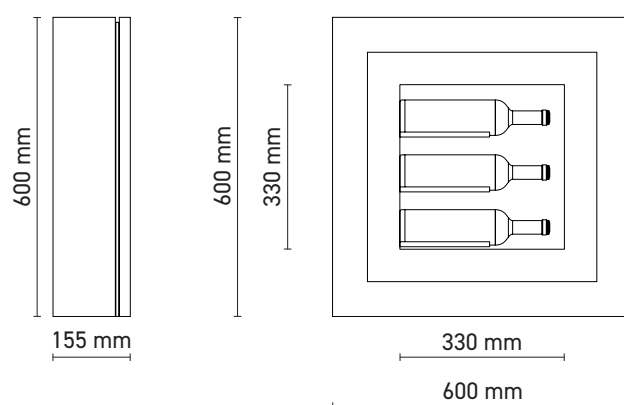

 + 8 / +20

Il QV30 permette di esporre 3 bottiglie di spumante e mantenerle a giusta temperatura di servizio. Su questo modello è possibile scegliere l'opzione dell'esposizione in verticale delle bottiglie ideale per un servizio al bicchiere.

QV30 allows you to display 3 bottles of sparkling wine and keep them at the right temperature. This model features a vertical bottle display option, ideal for service by the glass.

Le QV30 vous permet d'exposer 3 bouteilles de vin mousseux et de les garder à la bonne température. Sur ce modèle, il est possible choisir l'option de l'exposition des bouteilles en vertical, idéal pour le service au verre.



Quadro Vino n. 40



QV40

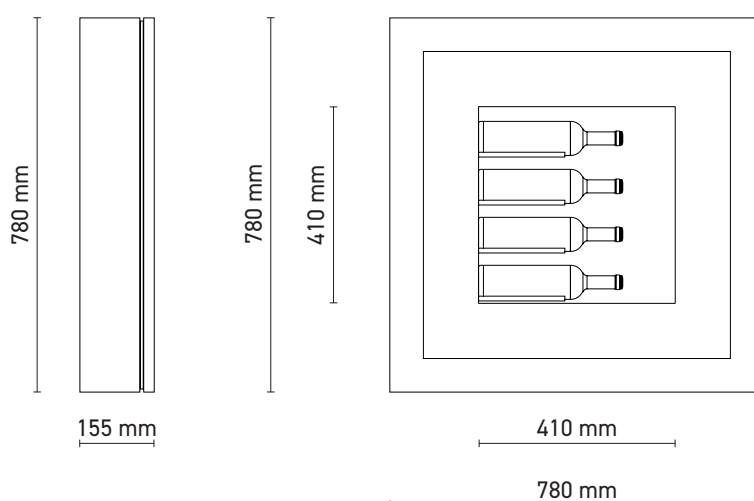

+ 12 / +20

Il QV 40 è un oggetto assolutamente innovativo, dal design raffinato, capace di rendere speciale qualsiasi ambiente. Trova facile inserimento nel ristorante e nell'hotel ma anche nelle residenze private. Su questo modello è possibile scegliere l'opzione dell'esposizione in verticale delle bottiglie ideale per un servizio al bicchiere.

QV40 is an innovative article with a sophisticated design which will make any setting special. It is suited for restaurants, hotels, and private homes alike. This model features a vertical bottle display option, ideal for service by the glass.

Le QV40 est un objet totalement nouveau, design raffiné, capable de rendre tout ambiance spécial. Peut être installé dans le restaurant, l'hôtel ainsi que dans des résidences privées. Sur ce modèle, vous pouvez choisir l'option d'exposition des bouteilles en vertical, idéale pour le service vin au verre.



Quadro Vino n. 52



QV52

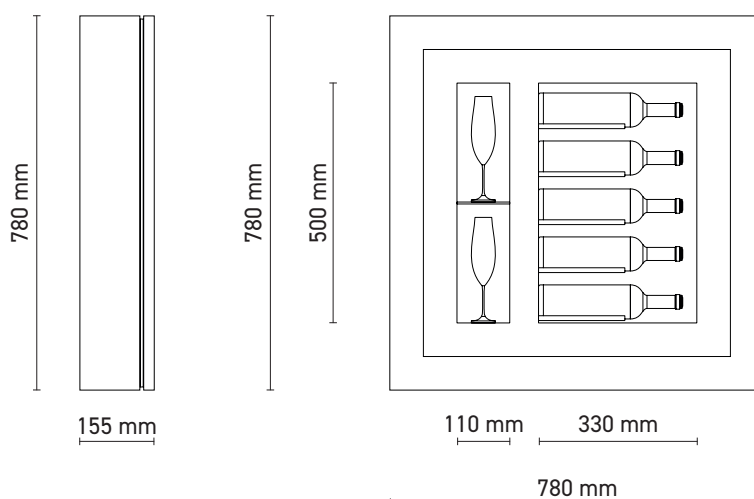

+ 12 / +20

Il QV52 è un espositore climatizzato per cinque bottiglie e due bicchieri, un nuovo modo di esporre, conservare e servire il vino.

Aprire un quadro, prendere una bottiglia di vino e servirla ad una temperatura di 16 °C è un'azione assolutamente nuova che non avremmo mai pensato possibile.

È uno speciale complemento d'arredo che, inserito in cucina o nel salotto, piuttosto che nella sala di un ristorante o di un hotel, non può passare inosservato.

QV52 is a refrigerated display for five bottles and two glasses: a new way to display, store and serve wine.

Opening the frame, taking out a bottle of wine and serving it at a temperature of 16 °C is something we could have never imagined before.

A special element that – added to your kitchen and living room, or the dining room of a restaurant or a hotel – cannot go unnoticed.

Le QV52 est une vitrine réfrigérée pour cinq bouteilles et deux verres, une nouvelle façon d'exposer, stocker et servir le vin.

Ouvrir un cadre du tableau, prendre une bouteille de vin et le servir à une température de 16 °C est une action totalement nouvelle que nous ne pensions pas possible.

Il est un détail de l'ameublement spécial qui, inseré dans la cuisine ou le salon, plutôt que dans la salle à manger d'un restaurant ou d'un hôtel, ne peut passer inaperçu.

Quadro Vino

Il Quadro Vino permette di conservare e servire vini diversi alla giusta temperatura. La refrigerazione è ottenuta con un silenzioso impianto termoelettrico dal consumo molto limitato. La minima profondità consente l'installazione anche in spazi molto ridotti.

Il Quadro Vino ha un impianto di refrigerazione ecologico privo di gas inquinanti ed è costruito con materiali riciclabili. La sostituzione dei componenti è semplice e rende sempre conveniente la riparazione del prodotto.

Quadro Vino allows you to preserve and serve different wines at the right temperature. Refrigeration is achieved thanks to a silent thermoelectrical system with very low consumption. Its minimal depth allows for installation even in small spaces.

Quadro Vino employs a green refrigeration system polluting gas-free and is made with recyclable materials. Replacement of spare parts is easy and therefore product maintenance is convenient.

Quadro Vino permet de stocker et servir différents vins à la correcte température. La réfrigération est obtenue par un système thermoélectrique silencieux à la consommation d'énergie très faible. La profondeur réduite permet une installation dans des petits espaces.

Quadro Vino dispose d'un système de réfrigération écologique sans la présence de gaz polluant et il est fabriqué avec des matériaux recyclables. Le remplacement des composants est simple et rend toujours économique la réparation du produit.

CARATTERISTICHE TECNICHE

Specifications • Caracteristiques techniques

Struttura in metallo
Struttura porta in alluminio
Cornice in legno / hpl / MDF
Vetrocamera 20 mm
Guarnizione magnetica
Pannello interno in laminato
Illuminazione a LED
Impianto termoelettrico
Sbrinamento automatico
Refrigerazione ventilata
Sistema di antivibrazione

*Metal structure
Aluminum door structure/core
Wood / HPL / MDF door frame
20 mm double glazing
Magnetic gasket
Internal laminate panel
LED lighting
Thermoelectric system
Automatic defrosting
Ventilated refrigeration
Anti-vibrate system*

*Structure métallique
Structure porte en aluminium
Cadre en bois / HPL / MDF
Double vitrage 20 mm
Joint magnétique
Panneau interne en laminé
Éclairage à LED
Système thermoélectrique
Dégivrage automatique
Réfrigération ventilée
Système anti-vibration*

CONFIGURATORE ONLINE

Online builder • Outil de configuration en ligne

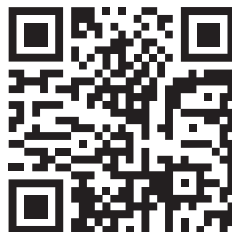

MODELLO • MODEL • MODÈLE



QV12



QV30



QV40



QV52

1 - STRUTTURA • STRUCTURE • STRUCTURE



RAL 9010

bianco
white
blanche

B



RAL 9005

nero
black
noir

N

2 - CORNICI • FRAMES • CADRES



3 - PANNELLI • PANELS • PANNEAUX

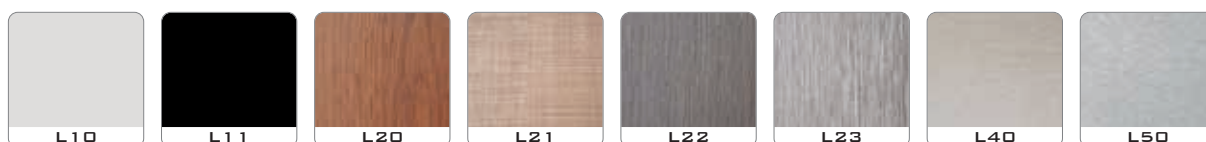

COLORE LUCE • LIGHT COLOUR • COLORIS LUMIÈRE

Standard



LED bianco naturale
white natural daylight LED
LED blanc day-light naturel

Optional



LED blu
blue LED
LED bleu

OPT-QLB

ALLESTIMENTO BOTTIGLIE VERTICALI

Vertical bottles accomodation • Logement bouteilles en vertical

QV-OPT-BV



Sui modelli QV30 e QV40 è possibile richiedere l'optional allestimento bottiglie verticali. Durante la fase finale di costruzione vengono rimossi i tondini portabottiglie e sostituiti con degli appositi tappi affinché sia sempre possibile ripristinare l'allestimento standard con bottiglie orizzontali.

Con questa soluzione si può utilizzare il Quadro Vino anche per il servizio al bicchiere in quanto è possibile inserire e mantenere a giusta temperatura anche le bottiglie già aperte.

Models QV30 and QV40 feature a vertical bottle fitting option. During the final phase of construction, support rods are removed and replaced with caps so that you can always restore the standard configuration with horizontal bottles.

With this solution you can use the QUADRO VINO for the service by the glass as you can set and maintain the right temperature even for open bottles.

Sur les modèles QV30 et QV40 il est possible avoir sur demande l'option de logement vertical des bouteilles. Pendant la phase finale de construction les tiges sont supprimés et remplacés par des bouchons appropriés de sorte que vous pouvez toujours restaurer la configuration standard avec des bouteilles horizontales.

Avec cette solution, vous pouvez utiliser le QUADRO VINO pour le service du vin au verre car vous pouvez saisir et de maintenir la bonne température, même les bouteilles ouvertes.

HPL laminato alta pressione • high pressure laminate • stratifiés haute pression



L10
bianco opaco
matt white
blanc mat

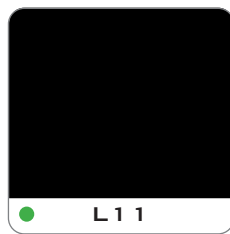

L11
nero opaco
matt black
noir mat

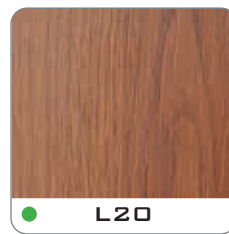

L20
castagno
chestnut
chêne



L21
teak roble
teak roble
teck rouvre

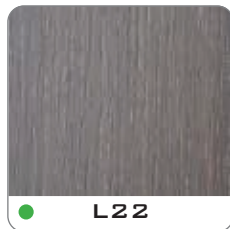

L22
wengé loft
loft wenge
wenge loft



L23
larice cenere
ash Larch
mélèze cendre

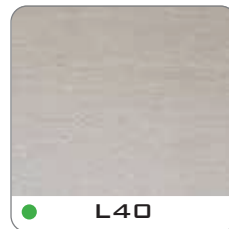

L40
cemento tortora
dove concrete
ciment taupe

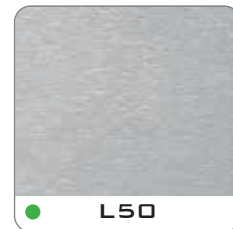

L50
acciaio satinato
satin-finish steel
acier satiné

MDF non verniciato • No finish MDF • MDF non peinte



MD1
MDF non verniciato
no finish MDF
MDF non peinte

Verniciatura a liquido • Liquid paint finish • Laquage par peinture liquide

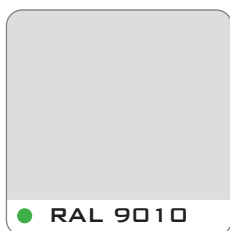

RAL 9010
bianco opaco (20 gloss)
matt white (20 gloss)
blanc mat (20 gloss)

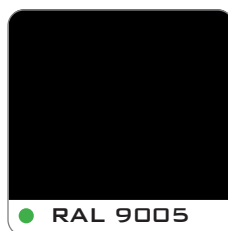

RAL 9005
nero opaco (20 gloss)
matt black (20 gloss)
noir mat (20 gloss)



VO1
verniciato oro
gold painted
peinture or



VO2
verniciato argento
silver painted
peinture argent



RAL 20 / 100
opaco 20 gloss - lucido 100 gloss
matte 20 gloss - polished 100 gloss
mat 20 gloss - brillant 100 gloss

Verniciatura a liquido (Dune) • Liquid paint finish (Dune) • Laquage par peinture liquide (Dune)



● DRAL 9010

bianco opaco (20 gloss)
matt white (20 gloss)
blanc mat (20 gloss)

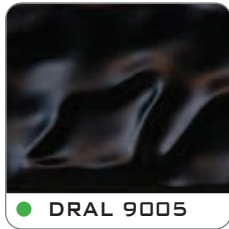

● DRAL 9005

nero opaco (20 gloss)
matt black (20 gloss)
noir mat (20 gloss)



● DVO 1

verniciato oro
gold painted
peinture or



● DVO 2

verniciato argento
silver painted
peinture argent

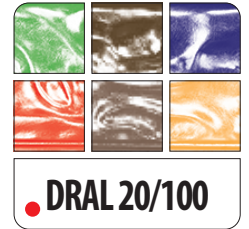

● DRAL 20/100

opaco 20 gloss - lucido 100 gloss
matte 20 gloss - polished 100 gloss
mat 20 gloss - brillant 100 gloss

Dune non verniciato • Dune no finish • Dune non peinte



● DDO 1

Dune non verniciato
Dune no finish
Dune non peinte



● DFO 1

oro patinato
gold coated
revêtement or



● DFO 2

argento patinato
silver coated
revêtement argent

Rivestimento in foglia (Dune) • Leaf finish (Dune)

Colorazioni speciali RAL

Special RAL colors

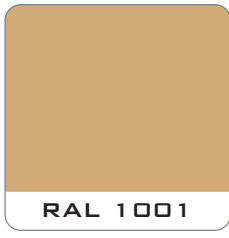

RAL 1001

BEIGE

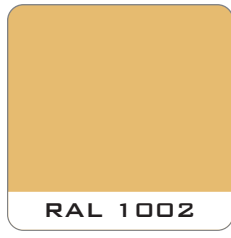

RAL 1002

SAND YELLOW

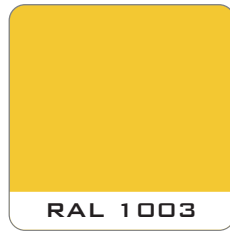

RAL 1003

SIGNAL YELLOW

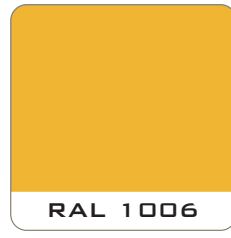

RAL 1006

MAIZE YELLOW

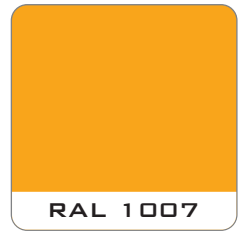

RAL 1007

DAFFODIL YELLOW



RAL 1011

BROWN BEIGE

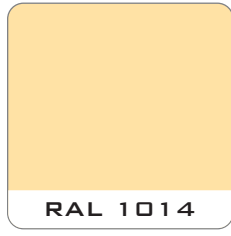

RAL 1014

IVORY



RAL 1015

LIGHT IVORY



RAL 1019

GREY BEIGE



RAL 1024

OCHRE YELLOW

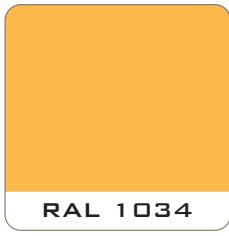

RAL 1034

PASTEL YELLOW



RAL 2000

YELLOW ORANGE



RAL 2003

PASTEL ORANGE



RAL 2010

SIGNAL ORANGE

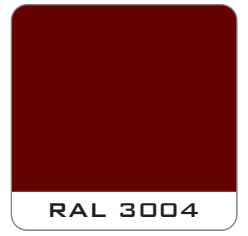

RAL 3004

PURPLE RED



RAL 3005

WINE RED



RAL 3007

BLACH RED

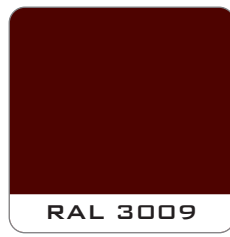

RAL 3009

OXIDE RED



RAL 3012

BEIGE RED



RAL 3017

ROSE



RAL 3031

ORIENT RED



RAL 4001

RED LILAC



RAL 4004

CLARET VIOLET

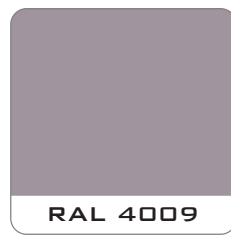

RAL 4009

PASTEL VIOLET



RAL 5003

SAPPHIRE BLUE



RAL 5004

BLACK BLUE



RAL 5005

SIGNAL BLUE



RAL 5008

GREY BLUE



RAL 5012

LIGHT BLUE



RAL 5014

PIGEON BLUE

 RAL 5020 OCEAN BLUE	 RAL 6005 MOSS GREEN	 RAL 6011 RESEDA GREEN	 RAL 6019 PASTEL GREEN	 RAL 7000 SQUIRREL GREY
 RAL 7001 SILVER GREY	 RAL 7003 MOSS GREY	 RAL 7004 SIGNAL GREY	 RAL 7006 BEIGE GREY	 RAL 7011 IRON GREY
 RAL 7030 STONE GREY	 RAL 7032 PEBBLE GREY	 RAL 7035 LIGHT GREY	 RAL 7036 PLATINUM GREY	 RAL 7042 TRAFFIC GREY A
 RAL 8002 SIGNAL BROWN	 RAL 8007 FAWN BROWN	 RAL 8014 SEPIA BROWN	 RAL 8017 CHOCOLATE BROWN	 RAL 8019 GREY BROWN
 RAL 8022 BLACK BROWN	 RAL 8025 PALE BROWN	 RAL 8028 TERRA BROWN	 RAL 9001 CREAM	 RAL 9002 GREY WHITE
 RAL 9003 SIGNAL WHITE	 RAL 9004 SIGNAL BLACK	 RAL 9005 JET BLACK	 RAL 9010 PURE WHITE	 RAL 9016 TRAFFIC WHITE

I colori stampati in questa cartella sono indicativi
The colours printed and shown in this folder are merely indicative
Les coloris imprimés ici sont indicatifs

Legenda





























LEGEND



LÉGENDE



CODE	Codice	Code	Code
	Temperatura (Temperatura ambiente 25 °C - Umidità relativa 50%)	Temperature (Ambient temperature 25°C - Relative humidity 50%)	Température (Température ambiante 25°C - Humidité relative 50%)
	Umidità (Temperatura ambiente 25 °C - Umidità relativa 50%)	Humidity (Ambient temperature 25°C - Relative humidity 50%)	Humidité (Température ambiante 25°C - Humidité relative 50%)
	Versione	Version	Version
	Refrigerato	Cooled	Réfrigéré
	Neutro	Neutral	Neutre
	Piastr e eutettiche	Eutectic plates	Plaques eutectiques
	Riscaldato	Heated	Chauffant
	Ventilato	Ventilated	Ventilé
	Ventole interne spente	Internal fans off	Ventilation interne désactivée
	Ventole interne accese	Internal fans on	Ventilation interne activée
	Rumorosità	Noise level	Bruyance
	Tensione	Voltage	Tension
	Assorbimento	Absorption	Absorption
Class	Classe energetica	Energy class	Classe énergétique
	Modello compressore	Compressor type	Modèle du compresseur
HFC	Gas refrigerante	Refrigerant gas	Gaz réfrigérant
	Quantità gas	Gas amount	Quantité de gaz
	Numero piastr e eutettiche	Number of eutectic plates	Nombre de plaques eutectiques
LIGHT	Luce	Light	Lumière
	Led bianco naturale (4000 K - 30 led/mt - 7,2 W / mt - 572 lumen / mt)	White natural daylight LED (4000 K - 30 led/mt - 7,2 W / mt - 572 lumen / mt)	LED blanc day-light naturel (4000 K - 30 led/mt - 7,2 W / mt - 572 lumen / mt)
	Led bianco caldo (3000 K - 60 led/mt - 14,4 W / mt - 900 lumen / mt)	brightwhite warm LED (3000 K - 60 led/mt - 14,4 W / mt - 900 lumen / mt)	LED blanc chaud (3000 K - 60 led/mt - 14,4 W / mt - 900 lumen / mt)
	Led blu	Blue LED	LED bleue
	Controller RGB (30 led/mt - 7,2 W / mt - 550 lumen / mt)	RGB controller (30 led/mt - 7,2 W / mt - 550 lumen / mt)	Regulateur RGB (30 led/mt - 7,2 W / mt - 550 lumen / mt)
	Controller bianco dinamico (2700/6000 K - 140 led/mt - 19,2 W / mt - 2000 lumen / mt)	Dinamic white controller (2700/6000 K - 140 led/mt - 19,2 W / mt - 2000 lumen / mt)	Regulateur blanc dynamique (2700/6000 K - 140 led/mt - 19,2 W / mt - 2000 lumen / mt)
	Cornice lineare	Linear frame	Cadre linéaire
	Cornice Dune	Dune frame	Cadre Dune

	Finitura metallo	Metal finish	Finition métal
	Nikel satinato	Satin nickel	Nickel satiné
	Oro lucido	Glossy gold	Doré brillant
	Lato posteriore vetrina	Showcase back side	Face postérieure vitrine
	Ante in vetro	Glass doors	Porte en verre
	Pannello cieco	Blank panel	Panneau borgne
	Numero piani (base compresa)	Number of shelves (including base)	Nombre de tablettes (base comprise)
	Numero cassetti	Number of drawers	Nombre de tiroirs
	Numero ante	Number of doors	Nombre de portes
	Numero bottiglie	Number of bottles	Nombre de bouteilles
	Altezza / diametro bottiglie	Bottle height / diameter	Hauteur/ diamètre bouteilles
	Kit salumeria	Salami kit	Kit salaisons
	Colore spalla	Shoulder colour	Coloris côté
	Presente	Present	Présent
-	Assente / dato non disponibile	Absent / data not available	Absent / information non disponible
	Volume interno	Internal volume	Capacité intérieure
	Dimensioni nette	Net dimensions	Dimensions nettes
	Dimensioni con imballo	Dimensions including packaging	Dimensions avec emballage
	Dimensioni con imballo su pedana	Dimensions including packaging on pallet	Dimensions avec emballage sur palette
	Peso netto	Net weight	Poids net
	Peso con imballo	Weight with packaging	Poids avec emballage
	Peso con imballo su pedana	Weight with packaging on pallet	Poids avec emballage sur palette
	Volume con imballo	Volume with packaging	Volume avec emballage
	Volume con imballo su pedana	Volume with packaging on pallet	Volume avec emballage sur palette
	Imballo in legno	Wooden packaging	Emballage en bois
DS	Descrizione	Description	Description
	Dimensione ventola	Fan blade size	Dimension du ventilateur
	∅ mm - Connesioni (liquido - aspirazione)	∅ mm - Connections (liquid - suction)	∅ mm - Connexions (liquide - aspiration)