

Water

Water, like air, is a fluid transparent and vital element. Falmecc transfers its experience from one element to the other, presenting a range of solutions for the use of water in the most active environment at home: the kitchen.







The perfect match

Falmec quality for all kitchen elements. From cooker hoods to integrated cooking systems, Falmec is synonymous with excellence, cutting-edge research, design and product culture. A synthesis of the best of Made in Italy that today finds further confirmation and solutions in a range of sinks, taps and accessories to better experience every sensation in the kitchen.

Falmec Water.

The Falmec Water collection stems from the same passion for technological and aesthetic innovation, as well as from the deep care for details that characterize the entire Falmec word. Today hoods, hobs, sinks and taps achieve ideal stylistic and functional harmony, fitting perfectly into the design of the kitchen environment and conveying emotions that last over time.

Details that make the difference

Construction Perfection.

The sinks of the Falmecc Water collection are made of AISI 304 steel, a material that ensures maximum resistance, durability and ease of cleaning. Thanks to the accurate welding process, the internal walls of the sinks are perfectly straight and the bottom has an inclination designed to allow the complete discharge of water. The result is flawless in terms of functionality and in line with contemporary design trends. The steel, with a thickness of 1 mm uniform over the entire surface of the sink, gives the object an absolute solidity and ability to absorb any shocks. A manufacturing quality that is perceived at first sight and lasts over time.

Falmecc Draining System.

The special Falmecc Draining System consists of a round steel cover, inserted flush with the flared drain hole, which guarantees perfect water drainage and easier cleaning. This solution also ensures a perfect visual continuity and uniformity of material on the bottom of the sink, hiding the functional part and creating an absolute balance of geometries.

Integrated overflow hole.



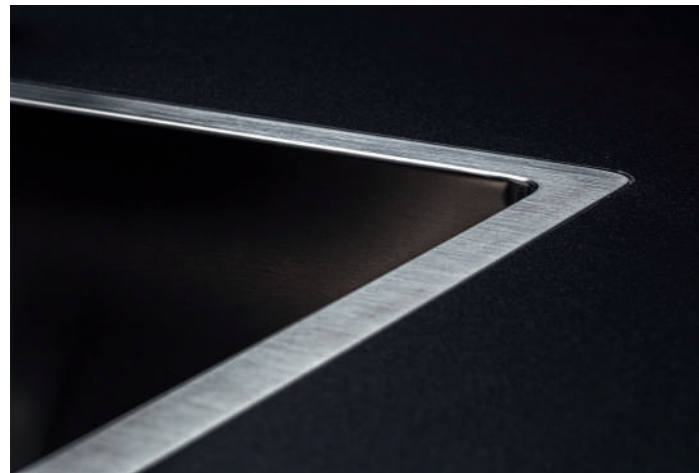







The overflow hole also has a rectangular steel cover that, placed flush on the vertical wall, makes it almost invisible.



Sinks

Como Stainless steel						
	14 Como 3118	15 Como 1831	16 Como 70	17 Como 50	18 Como 45	
						
	19 Como 40	20 Como 34	21 Como 18			
Como PVD						
	24 Como 50 Gunmetal	24 Como 50 Copper	24 Como 50 Gold			
Garda Stainless steel						
	28 Garda 3118	29 Garda 1831	30 Garda 70	31 Garda 50	32 Garda 40	33 Garda 34
Iseo Ceramik						
	36 Iseo 40 Black	37 Iseo 40 White	38 Iseo 5 0 Black	39 Iseo 50 White	40 Iseo 70 Black	41 Iseo 70 White

Water Taps

Pure Steel			
	51 Pure steel Flat	51 Pure steel Round	51 Pure steel Corner
Trevi			
	55 Trevi Round	55 Trevi Corner	55 Trevi Pro
Iseo			
	58 Iseo Round	58 Iseo Corner	
Easy			
	59 Easy Square	59 Easy Round	



Sinks

The pure technicality of steel, the seductive glow of precious metals, the innovative synthesis between nature and technology: the sinks of the Falmecc Water collection explore different material sensations to give a new aesthetic meaning to water. A complete offer, able to fit into different environments and contemporary furnishing contexts.

Collection

- Como
- Como PVD
- Garda
- Iseo

Como Collection

Essencial by nature.

Conceived to guarantee the absolute perfection of each detail, the sinks of the Como collection, with their essential design, enhance the pure beauty of shape and material.

Made exclusively of AISI 304 steel and offered in different sizes, they fit into any type of kitchen, enhancing aesthetics and functionality, thanks to the professionalism of their design, interpreted in harmony with the environment and domestic needs.



The internal corners have a 12 mm radius that allows for optimal ease of cleaning and stylistic elegance.

The Falmec Draining System characterizes the sink at first glance.



Types of installation

- Flushmount
- Topmount
- Undermount

Features

- AISI 304 18/10 stainless steel
- 1 mm regular thickness
- Inner corners radius 12 mm
- Scotch Brite finish
- 200 mm bowl depth
- Fixing kit included
- Perimeter overflow
- Falmec seamless drainage system
- Anti-noise fiber



Como 3118

- AISI 304 18/10 stainless steel
- 1 mm regular thickness
- Inner corners radius 12 mm
- Scotch Brite finish
- 200 mm bowl depth
- Fixing kit included
- Perimeter overflow
- Falmecc seamless drainage system
- Anti-noise fiber

Dimensions
 Cabinet 60 cm
 Ext dimension 555 x 440 mm
 Bowl dimension
 310 x 400 mm / 180 x 400 mm
 Bowl depth 200 / 170 mm

Accessories See page 62



Como 1831

- AISI 304 18/10 stainless steel
- 1 mm regular thickness
- Inner corners radius 12 mm
- Scotch Brite finish
- 200 mm bowl depth
- Fixing kit included
- Perimeter overflow
- Falmecc seamless drainage system
- Anti-noise fiber

Dimensions
 Cabinet 60 cm
 Ext dimension 555 x 440 mm
 Bowl dimension
 180 x 400 mm / 310 x 400 mm
 Bowl depth 170 / 200 mm

Accessories See page 62



Technical Drawings

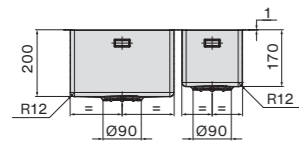
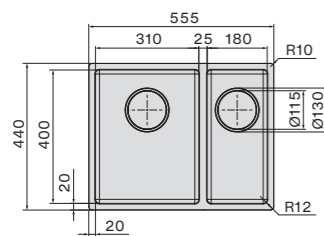

Codes and finishing

Type installation
 Code
 SCO3118F.00#SSF
 Finishing
 Stainless steel
 AISI 304

Flushmount

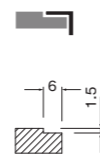

Cut-out size

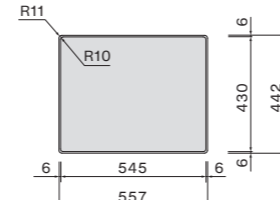

Type installation
 Code
 SCO3118F.00#SSF
 Finishing
 Stainless steel
 AISI 304

Topmount

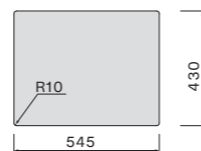

Suggested combinations

Pure steel collection



Trevi collection



Type installation
 Code
 SCO3118F.00#SSF
 Finishing
 Stainless steel
 AISI 304

Undermount

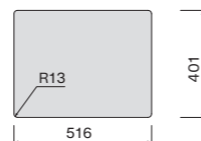

Technical Drawings

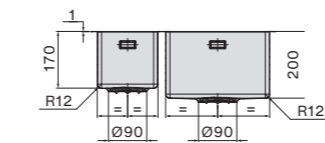
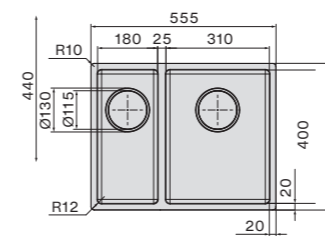

Codes and finishing

Type installation
 Code
 SCO1831F.00#SSF
 Finishing
 Stainless steel
 AISI 304

Flushmount

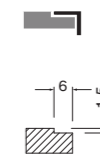

Cut-out size

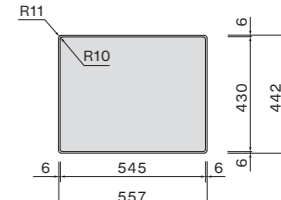

Type installation
 Code
 SCO1831F.00#SSF
 Finishing
 Stainless steel
 AISI 304

Topmount

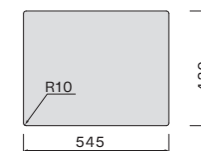

Suggested combinations

Pure steel collection



Trevi collection



Type installation
 Code
 SCO1831F.00#SSF
 Finishing
 Stainless steel
 AISI 304

Undermount

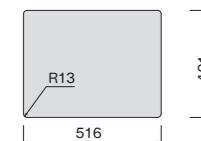

Como 70

- AISI 304 18/10 stainless steel
- 1 mm regular thickness
- Inner corners radius 12 mm
- Scotch Brite finish
- 200 mm bowl depth
- Fixing kit included
- Perimeter overflow
- Falmecc seamless drainage system
- Anti-noise fiber

Dimensions
 Cabinet 80 cm
 Ext dimension 740 x 440 mm
 Bowl dimension
 700 x 400 mm
 Bowl depth 200 mm

Accessories See page 62



Como 50

- AISI 304 18/10 stainless steel
- 1 mm regular thickness
- Inner corners radius 12 mm
- Scotch Brite finish
- 200 mm bowl depth
- Fixing kit included
- Perimeter overflow
- Falmecc seamless drainage system
- Anti-noise fiber

Dimensions
 Cabinet 60 cm
 Ext dimension 540 x 440 mm
 Bowl dimension
 500 x 400 mm
 Bowl depth 200 mm

Accessories See page 62



Technical Drawings

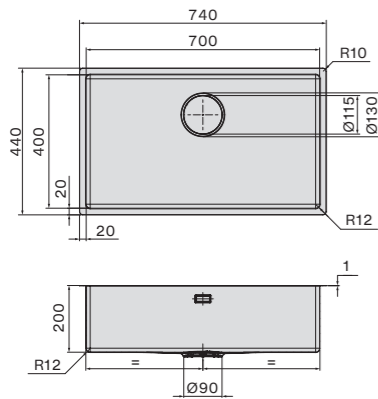

Codes and finishing

Type installation
 Code
 SCO7000F.00#SSF
 Finishing
 Stainless steel
 AISI 304

Flushmount

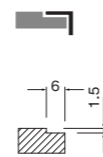

Cut-out size

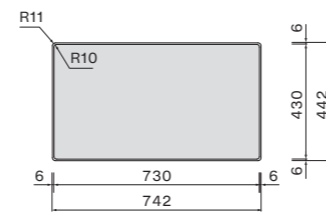

Type installation
 Code
 SCO7000F.00#SSF
 Finishing
 Stainless steel
 AISI 304

Topmount

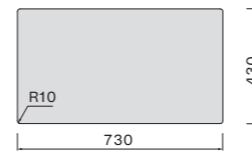

Suggested combinations



Type installation
 Code
 SCO7000U.00#SSF
 Finishing
 Stainless steel
 AISI 304

Undermount

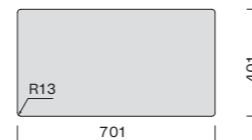

Technical Drawings

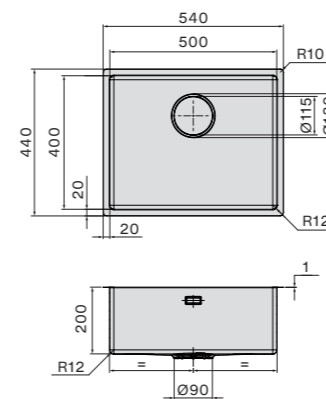

Codes and finishing

Type installation
 Code
 SCO5000F.00#SSF
 Finishing
 Stainless steel
 AISI 304

Flushmount

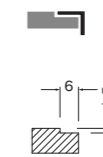

Cut-out size

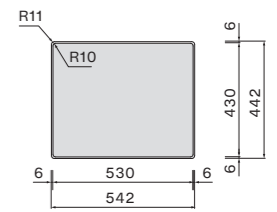

Type installation
 Code
 SCO5000F.00#SSF
 Finishing
 Stainless steel
 AISI 304

Topmount

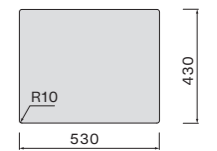

Suggested combinations



Type installation
 Code
 SCO5000U.00#SSF
 Finishing
 Stainless steel
 AISI 304

Undermount

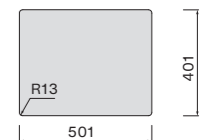

Como 45

- AISI 304 18/10 stainless steel
- 1 mm regular thickness
- Inner corners radius 12 mm
- Scotch Brite finish
- 200 mm bowl depth
- Fixing kit included
- Perimeter overflow
- Falmecc seamless drainage system
- Anti-noise fiber

Dimensions
 Cabinet 50 cm
 Ext dimension 490 x 440 mm
 Bowl dimension
 450 x 400 mm
 Bowl depth 200 mm

Accessories See page 62

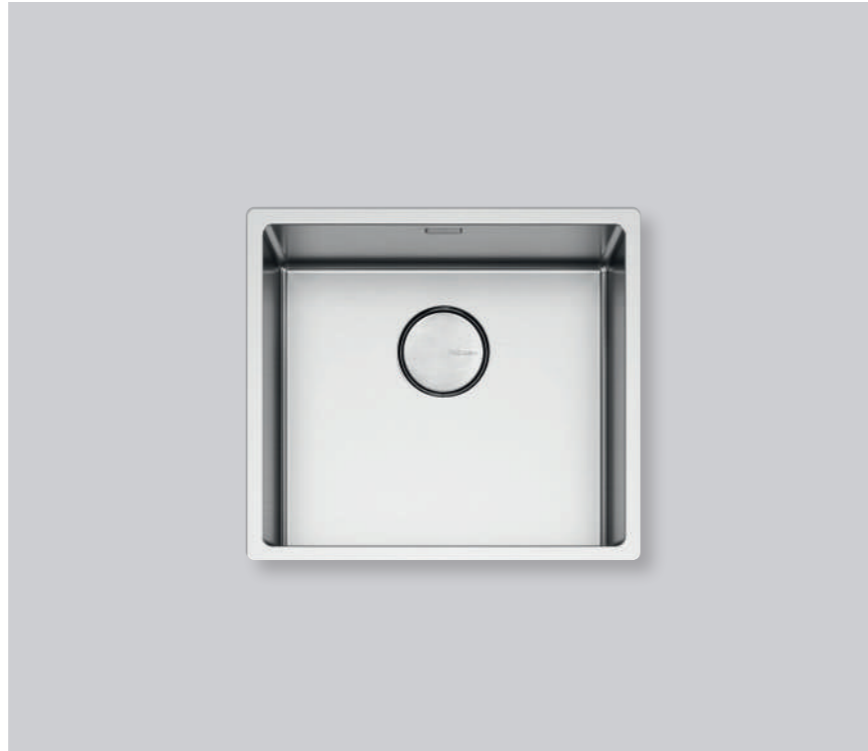

Como 40

- AISI 304 18/10 stainless steel
- 1 mm regular thickness
- Inner corners radius 12 mm
- Scotch Brite finish
- 200 mm bowl depth
- Fixing kit included
- Perimeter overflow
- Falmecc seamless drainage system
- Anti-noise fiber

Dimensions
 Cabinet 50 cm
 Ext dimension 440 x 440 mm
 Bowl dimension
 400 x 400 mm
 Bowl depth 200 mm

Accessories See page 62

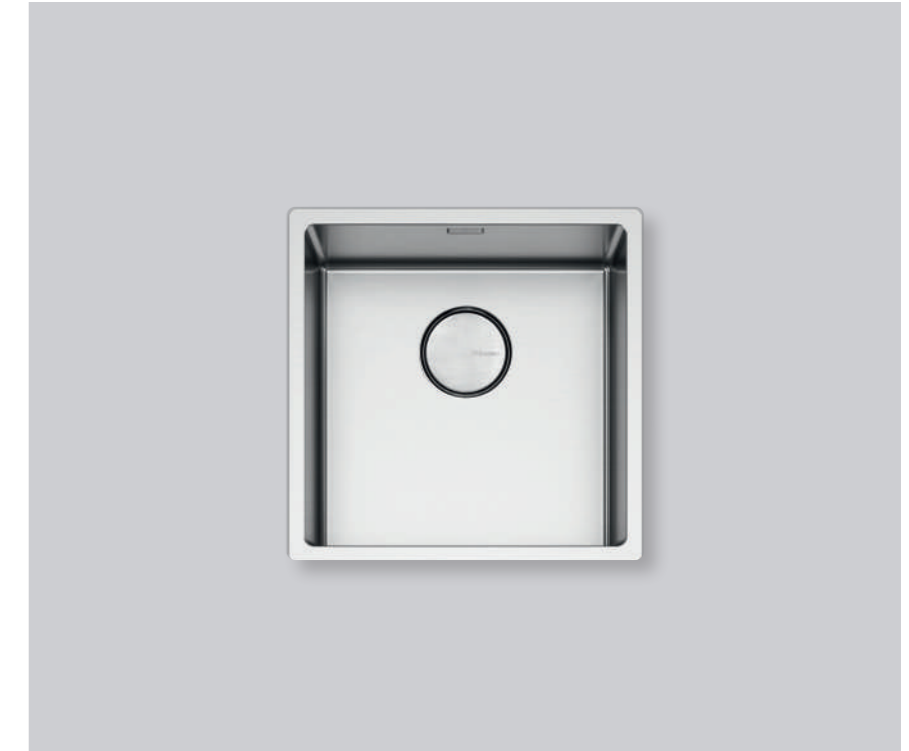

Technical Drawings

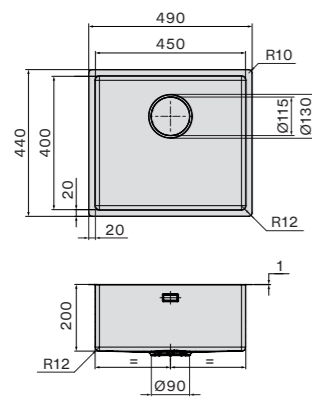

Codes and finishing

Type installation
 Code
 SCO4500F.00#SSF
 Finishing
 Stainless steel
 AISI 304

Flushmount

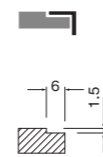

Cut-out size

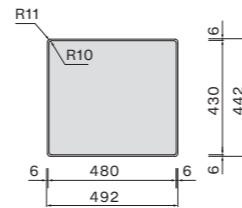

Type installation
 Code
 SCO4500T.00#SSF
 Finishing
 Stainless steel
 AISI 304

Topmount

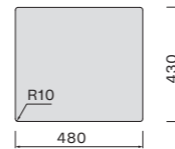

Suggested combinations



Type installation
 Code
 SCO4500U.00#SSF
 Finishing
 Stainless steel
 AISI 304

Undermount

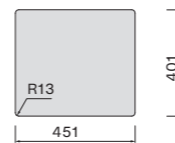

Technical Drawings

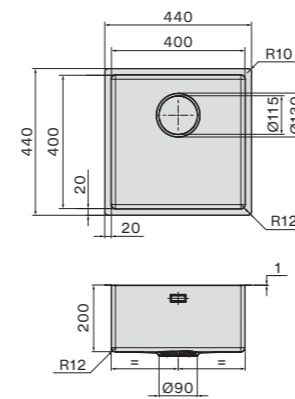

Codes and finishing

Type installation
 Code
 SCO4000F.00#SSF
 Finishing
 Stainless steel
 AISI 304

Flushmount

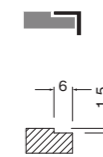

Cut-out size

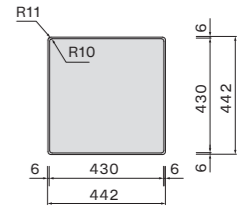

Type installation
 Code
 SCO4000T.00#SSF
 Finishing
 Stainless steel
 AISI 304

Topmount

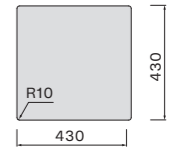

Suggested combinations



Type installation
 Code
 SCO4000U.00#SSF
 Finishing
 Stainless steel
 AISI 304

Undermount



Como 34

- AISI 304 18/10 stainless steel
- 1 mm regular thickness
- Inner corners radius 12 mm
- Scotch Brite finish
- 200 mm bowl depth
- Fixing kit included
- Perimeter overflow
- Falmecc seamless drainage system
- Anti-noise fiber

Dimensions
 Cabinet 40 cm
 Ext dimension 380 x 440 mm
 Bowl dimension
 340 x 400 mm
 Bowl depth 200 mm

Accessories See page 62

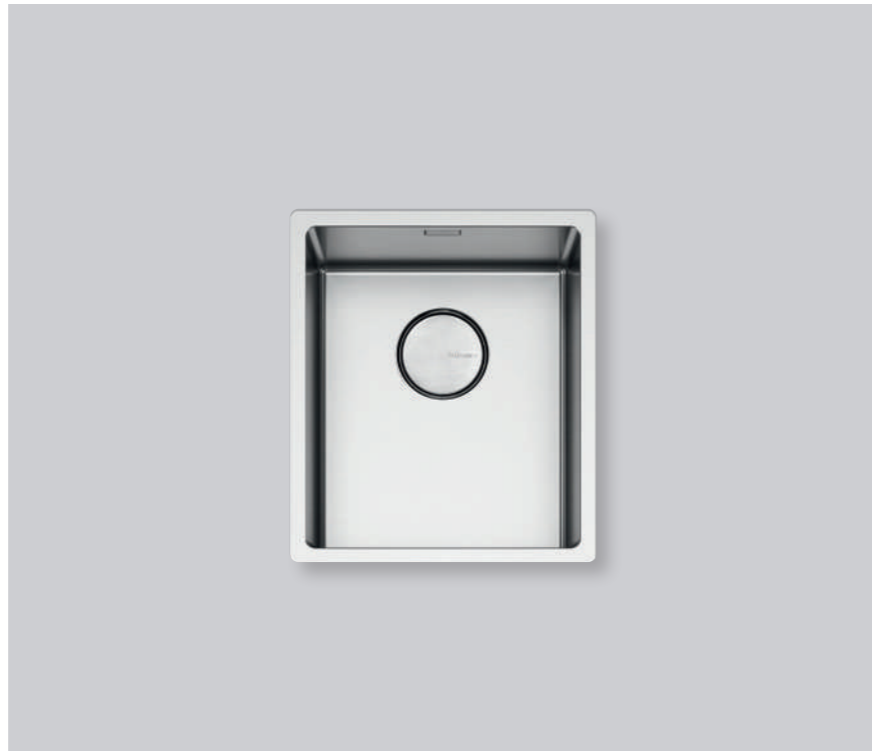

Como 18

- AISI 304 18/10 stainless steel
- 1 mm regular thickness
- Inner corners radius 12 mm
- Scotch Brite finish
- 200 mm bowl depth
- Fixing kit included
- Perimeter overflow
- Falmecc seamless drainage system
- Anti-noise fiber

Dimensions
 Cabinet 30 cm
 Ext dimension 220 x 440 mm
 Bowl dimension
 180 x 400 mm
 Bowl depth 200 mm

Accessories See page 62



Technical Drawings

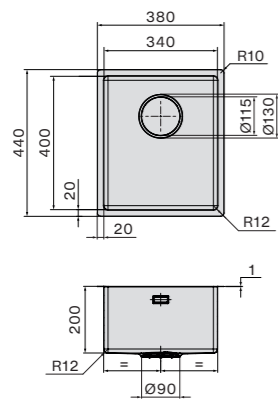

Codes and finishing

Type installation
 Code
 SCO3400F.00#SSF
 Finishing
 Stainless steel
 AISI 304

Flushmount

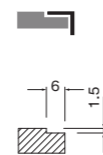

Cut-out size

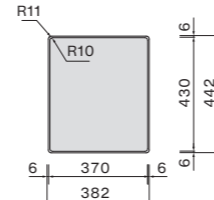

Type installation
 Code
 SCO3400T.00#SSF
 Finishing
 Stainless steel
 AISI 304

Topmount

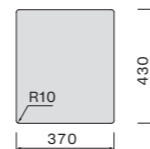

Suggested combinations



Type installation
 Code
 SCO3400U.00#SSF
 Finishing
 Stainless steel
 AISI 304

Undermount

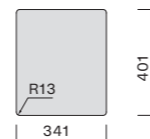

Technical Drawings

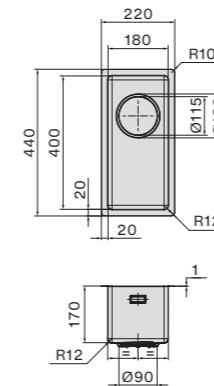

Codes and finishing

Type installation
 Code
 SCO1800F.00#SSF
 Finishing
 Stainless steel
 AISI 304

Flushmount

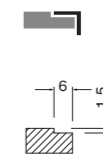

Cut-out size

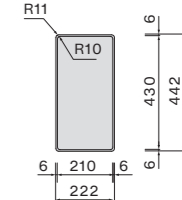

Type installation
 Code
 SCO1800T.00#SSF
 Finishing
 Stainless steel
 AISI 304

Topmount

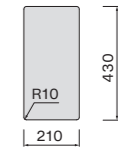

Suggested combinations



Type installation
 Code
 SCO1800U.00#SSF
 Finishing
 Stainless steel
 AISI 304

Undermount



Como PVD Collection

Brilliant design.

The PVD (Physical Vapor Deposition) treatment dresses the steel with an infinitesimal layer of metal particles that are deposited on the surface and become an integral part of it, creating different striking colors. Compared to other chemical finishes, this particular process ensures greater brilliance, resistance and durability. Moreover, it is totally hypoallergenic, non-toxic and eco-friendly.

The irresistible charm of gold, the timeless warmth of copper, the glamorous elegance of matte black help create a kitchen environment full of elegance and prestige.

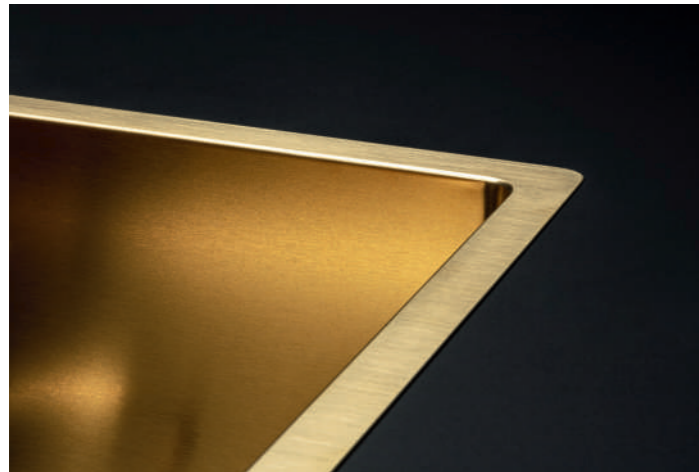

Gold, gunmetal, copper: Falmec introduces new emotions to the kitchen environment.

The flush-fitting circular lid, coordinated in the sink finish, is a strongly distinctive element of the Como PVD collection.



Como 50 PVD

- AISI 304 18/10 stainless steel with PVD finishing
- 1 mm regular thickness
- Inner corners radius 12 mm
- 200 mm bowl depth
- Fixing kit included
- Perimeter overflow
- Falmecc seamless drainage system
- Anti-noise fiber

Dimensions

Cabinet 60 cm
 Ext dimension 540 x 440 mm
 Bowl dimension
 500 x 400 mm
 Bowl depth 200 mm

Accessories See page 62

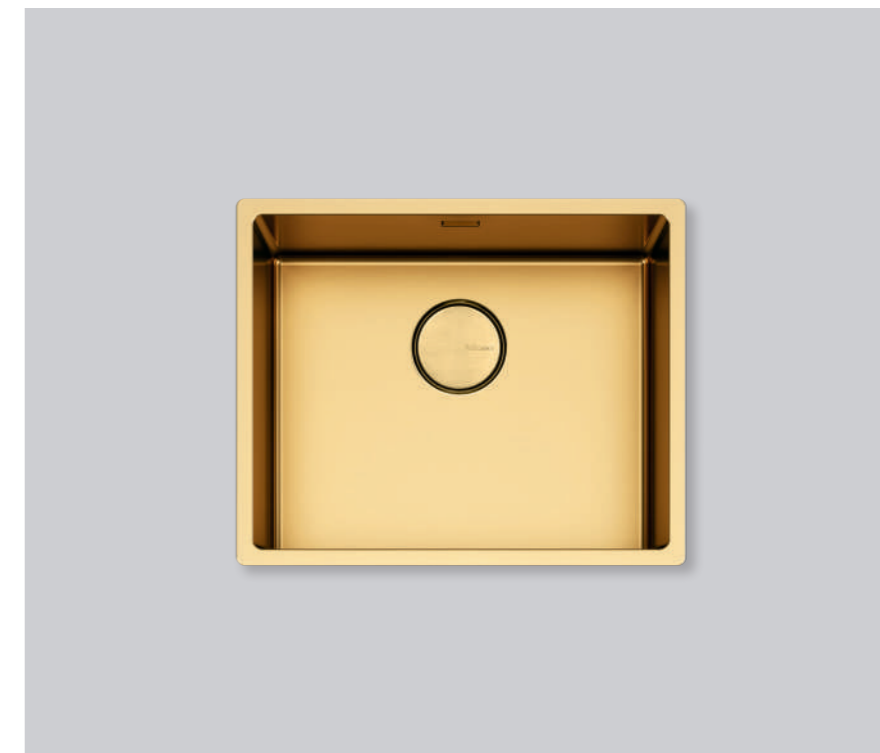

Technical Drawings

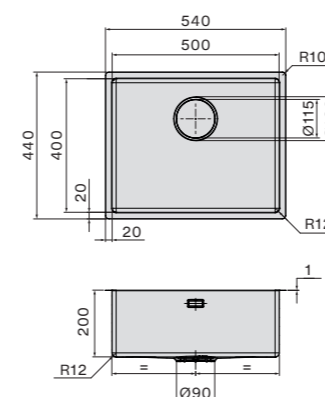

Codes and finishing

Type installation
 Code
 SCO5000F.00#PGF
 Finishing
 Gold

Type installation
 Code
 SCO5000F.00#PGF
 Finishing
 Gold

Type installation
 Code
 SCO5000F.00#PGF
 Finishing
 Gold

Cut-out size

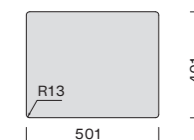
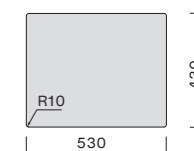
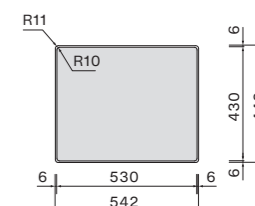
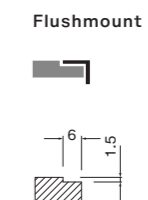

Suggested combinations

Trevi Round
 gold finishing



Trevi Pro
 gold finishing



Como 50 PVD

- AISI 304 18/10 stainless steel with PVD finishing
- 1 mm regular thickness
- Inner corners radius 12 mm
- 200 mm bowl depth
- Fixing kit included
- Perimeter overflow
- Falmeac seamless drainage system
- Anti-noise fiber

Dimensions
 Cabinet 60 cm
 Ext dimension 540 x 440 mm
 Bowl dimension
 500 x 400 mm
 Bowl depth 200 mm

Accessories See page 62



Como 50 PVD

- AISI 304 18/10 stainless steel with PVD finishing
- 1 mm regular thickness
- Inner corners radius 12 mm
- 200 mm bowl depth
- Fixing kit included
- Perimeter overflow
- Falmeac seamless drainage system
- Anti-noise fiber

Dimensions
 Cabinet 60 cm
 Ext dimension 540 x 440 mm
 Bowl dimension
 500 x 400 mm
 Bowl depth 200 mm

Accessories See page 62

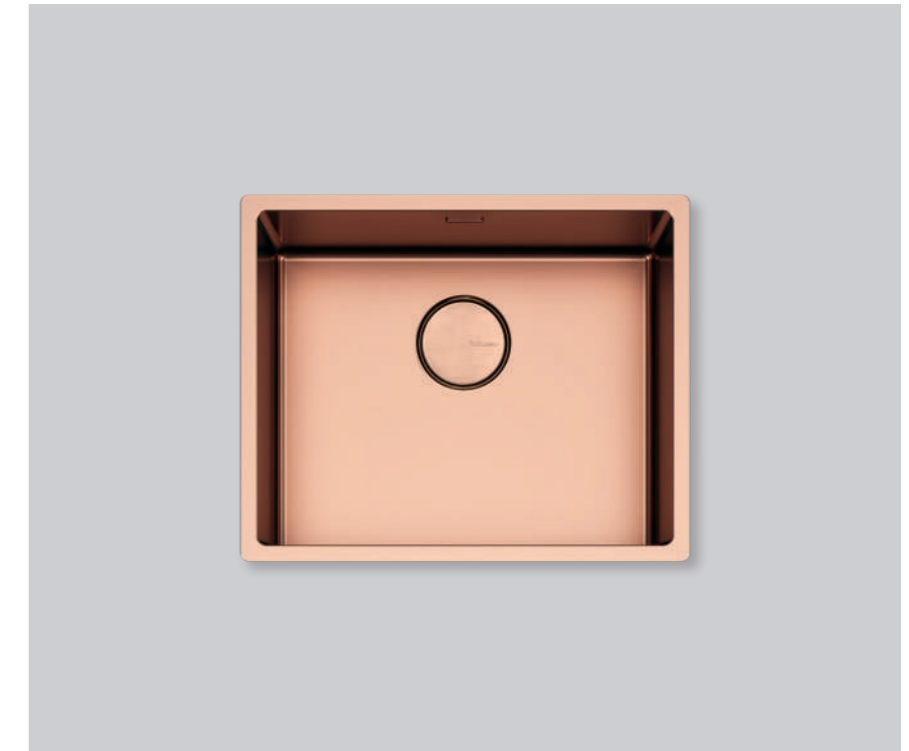

Technical Drawings

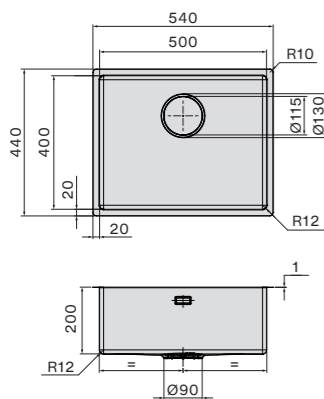

Codes and finishing

Type installation
 Code
 SC05000F.00#PPF
 Finishing
 Gunmetal

Flushmount

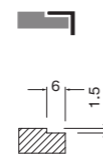

Cut-out size

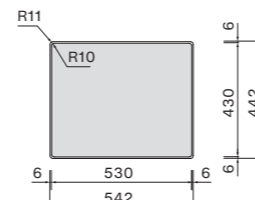

Type installation
 Code
 SC05000F.00#PPF
 Finishing
 Gunmetal

Topmount

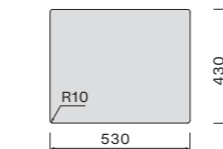

Suggested combinations

Trevi Round
 gunmetal
 finishing



Trevi Pro
 gunmetal
 finishing



Type installation
 Code
 SC05000F.00#PPF
 Finishing
 Gunmetal

Undermount

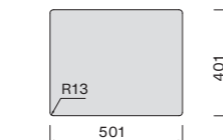

Technical Drawings

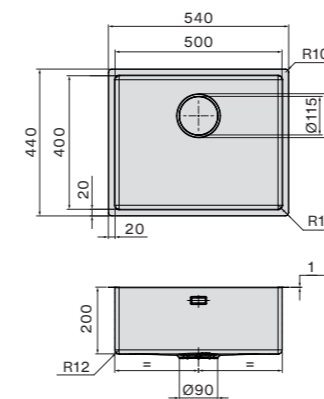

Codes and finishing

Type installation
 Code
 SC05000F.00#PQF
 Finishing
 Copper

Flushmount

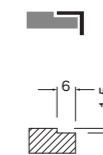

Cut-out size

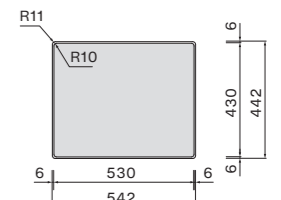

Type installation
 Code
 SC05000F.00#PQF
 Finishing
 Copper

Topmount

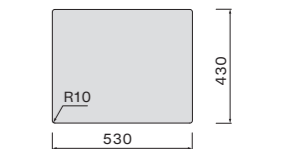

Suggested combinations

Trevi Round
 copper
 finishing



Trevi Pro
 copper
 finishing



Type installation
 Code
 SC05000F.00#PQF
 Finishing
 Copper

Undermount

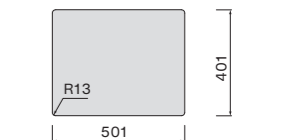

Garda Collection

Integrated solution.

Made of hand-welded AISI 304 steel, with a uniform thickness of 1mm to ensure the utmost precision in every detail and a very long life span. The sinks of the Garda collection have a reinforced back side designed for the insertion of taps.

Available in different sizes to fit easily into any kitchen environment, they stand out for their innovative integrated valve for draining liquids, conveniently located on the edge of the sink, and also for the exclusive Falmec Draining System with a flush-fit lid on the water drain.



The practical automatic drain valve, with circular button, is available in various finishes to best match the sink or worktop in which it is inserted.

This solution is installed as standard on the sinks of the Garda collection and is optional in the other collections of the Water range.

Types of installation

- Flushmount
- Topmount

Features

- AISI 304 18/10 stainless steel
- 1 mm regular thickness
- Inner corners radius 12 mm
- Scotch Brite finish
- 200 mm bowl depth
- Fixing kit included
- Perimeter overflow
- Falmec seamless drainage system
- Anti-noise fiber
- Automatic drain valve included



Garda Collection



Garda 3118

- AISI 304 18/10 stainless steel
- 1 mm regular thickness
- Inner corners radius 12 mm
- Scotch Brite finish
- 200 mm bowl depth
- Fixing kit included
- Perimeter overflow
- Falmecc seamless drainage system
- Anti-noise fiber
- Automatic drain valve included

Dimensions
Cabinet 60 cm
Ext dimension 555 x 510 mm
Bowl dimension
 310 x 400 / 180 x 400 mm
Bowl depth 200 / 170 mm

Accessories See page 62



Garda 1831

- AISI 304 18/10 stainless steel
- 1 mm regular thickness
- Inner corners radius 12 mm
- Scotch Brite finish
- 200 mm bowl depth
- Fixing kit included
- Perimeter overflow
- Falmecc seamless drainage system
- Anti-noise fiber
- Automatic drain valve included

Dimensions
Cabinet 60 cm
Ext dimension 555 x 510 mm
Bowl dimension
 180 x 400 / 310 x 400 mm
Bowl depth 200 / 170 mm

Accessories See page 62



Technical Drawings

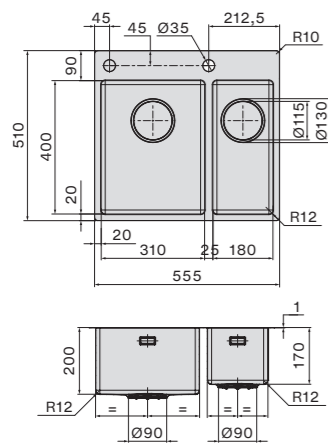

Codes and finishing

Type installation
Code
 SGA3118F.00#SSF
Finishing
 Stainless steel
 AISI 304

Flushmount

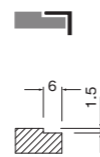

Cut-out size

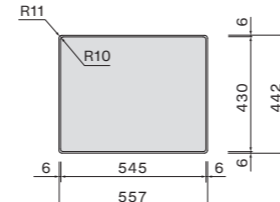

Type installation
Code
 SGA3118F.00#SSF
Finishing
 Stainless steel
 AISI 304

Topmount

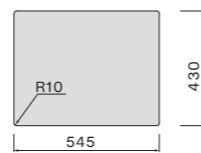

Suggested combinations

Pure steel collection

Trevi collection



Technical Drawings

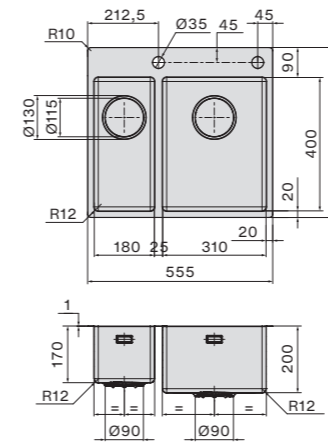

Codes and finishing

Type installation
Code
 SGA1831F.00#SSF
Finishing
 Stainless steel
 AISI 304

Flushmount

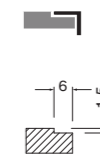

Cut-out size

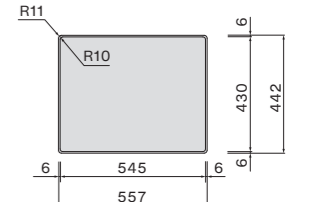

Type installation
Code
 SGA1831F.00#SSF
Finishing
 Stainless steel
 AISI 304

Topmount

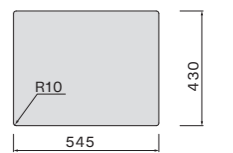

Suggested combinations

Pure steel collection

Trevi collection



Garda 70

- AISI 304 18/10 stainless steel
- 1 mm regular thickness
- Inner corners radius 12 mm
- Scotch Brite finish
- 200 mm bowl depth
- Fixing kit included
- Perimeter overflow
- Falmeac seamless drainage system
- Anti-noise fiber
- Automatic drain valve included

Dimensions
Cabinet 80 cm
Ext dimension 740 x 510 mm
Bowl dimension
 700 x 400mm
Bowl depth 200 mm

Accessories See page 62

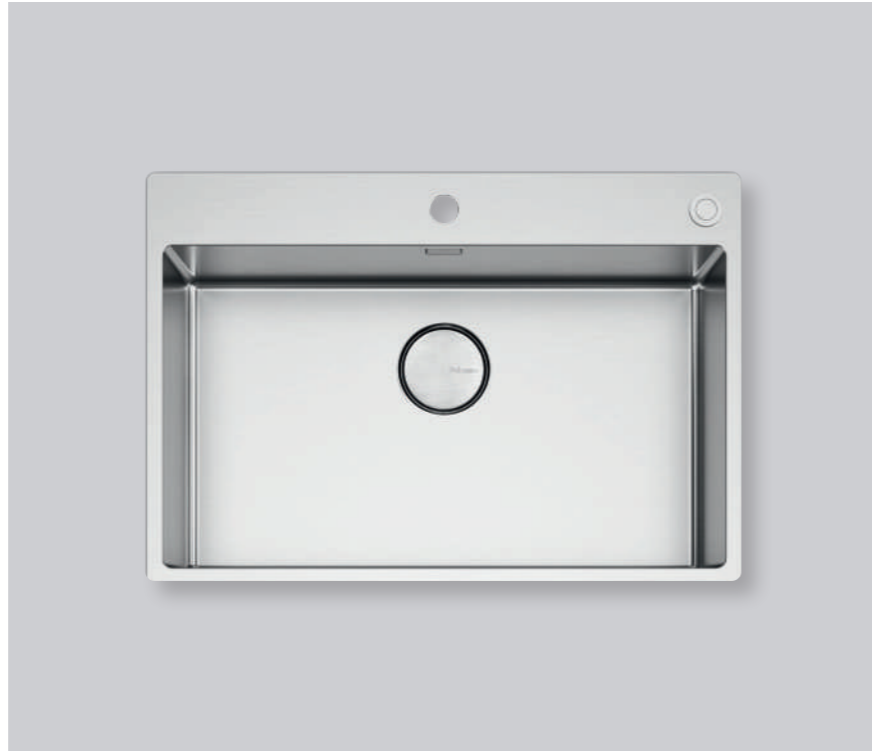

Garda 50

- AISI 304 18/10 stainless steel
- 1 mm regular thickness
- Inner corners radius 12 mm
- Scotch Brite finish
- 200 mm bowl depth
- Fixing kit included
- Perimeter overflow
- Falmeac seamless drainage system
- Anti-noise fiber
- Automatic drain valve included

Dimensions
Cabinet 60 cm
Ext dimension 540 x 510 mm
Bowl dimension
 500 x 400 mm
Bowl depth 200 mm

Accessories See page 62



Technical Drawings

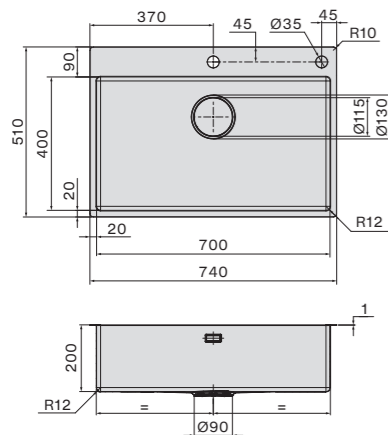

Codes and finishing

Type installation
Code
 SGA7000F.00#SSF
Finishing
 Stainless steel
 AISI 304

Type installation
Code
 SGA7000F.00#SSF
Finishing
 Stainless steel
 AISI 304

Flushmount

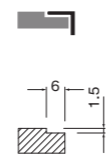

Topmount



Cut-out size

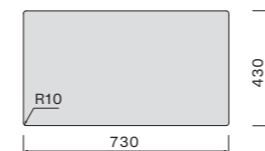
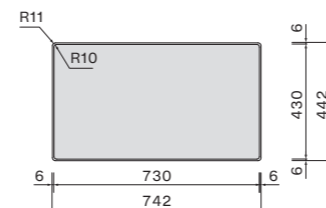

Suggested combinations

Pure steel collection

Trevi collection



Technical Drawings

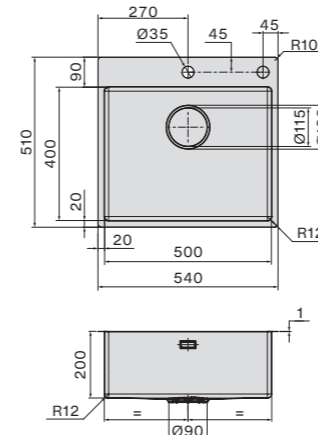

Codes and finishing

Type installation
Code
 SGA5000F.00#SSF
Finishing
 Stainless steel
 AISI 304

Type installation
Code
 SGA5000F.00#SSF
Finishing
 Stainless steel
 AISI 304

Flushmount

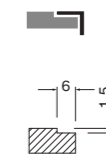

Topmount



Cut-out size

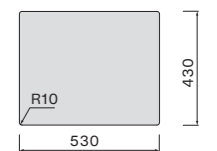
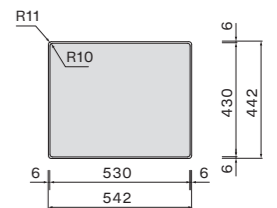

Suggested combinations

Pure steel collection

Trevi collection



Garda 40

- AISI 304 18/10 stainless steel
- 1 mm regular thickness
- Inner corners radius 12 mm
- Scotch Brite finish
- 200 mm bowl depth
- Fixing kit included
- Perimeter overflow
- Falmec seamless drainage system
- Anti-noise fiber
- Automatic drain valve included

Dimensions
 Cabinet 50 cm
 Ext dimension 440 x 510 mm
 Bowl dimension
 400 x 400mm
 Bowl depth 200 mm

Accessories See page 62



Garda 34

- AISI 304 18/10 stainless steel
- 1 mm regular thickness
- Inner corners radius 12 mm
- Scotch Brite finish
- 200 mm bowl depth
- Fixing kit included
- Perimeter overflow
- Falmec seamless drainage system
- Anti-noise fiber
- Automatic drain valve included

Dimensions
 Cabinet 60 cm
 Ext dimension 380 x 510 mm
 Bowl dimension
 340 x 400 mm
 Bowl depth 200 mm

Accessories See page 62



Technical Drawings

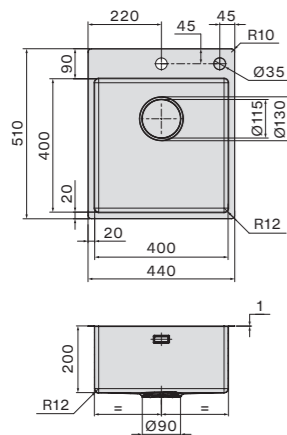

Codes and finishing

Type installation
 Code
 SGA4000F.00#SSF
 Finishing
 Stainless steel
 AISI 304

Flushmount

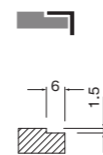

Cut-out size

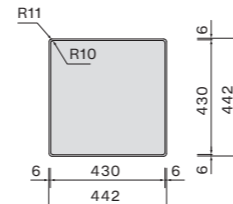

Type installation
 Code
 SGA4000F.00#SSF
 Finishing
 Stainless steel
 AISI 304

Topmount

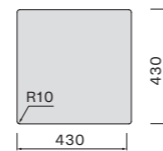

Suggested combinations

Pure steel collection

Trevi collection



Technical Drawings

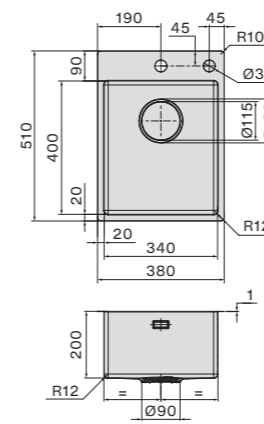

Codes and finishing

Type installation
 Code
 SGA3400F.00#SSF
 Finishing
 Stainless steel
 AISI 304

Flushmount

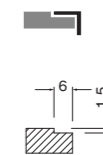

Cut-out size

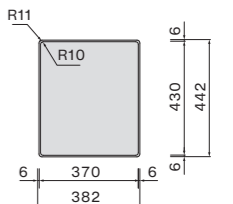

Type installation
 Code
 SGA3400F.00#SSF
 Finishing
 Stainless steel
 AISI 304

Topmount

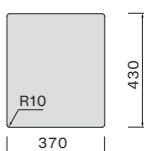

Suggested combinations

Pure steel collection

Trevi collection



Iseo Collection

Material innovation.

Composix comes from an avant-garde research: the innovative mix of ceramic nanoparticles and acrylic resins for a material with features that have never been reached before. Composix is made with 6 different resins that make it water-repellent and stain-resistant. This material is also characterized by a perfect uniformity of the surface, which is absolutely smooth and resistant to impact and abrasion.

Available in white or black version, the sinks of the Iseo collection have an essential design, with geometric shapes, conceived to fit perfectly into different kitchen environments, maintaining their aesthetic characteristics and functional performance over time.



Sturdy, smooth and compact, the innovative Composix material of Iseo guarantees chromatic uniformity, long life and ease of cleaning.

Types of installation

- Topmount
- Undermount

Features

- Composix finishing
- 6 mm slim edge
- 200 mm bowl depth
- Fixing kit included
- Perimeter overflow
- Materic cover





Iseo 40 Black

- Composit finishing
- 6 mm slim edge
- 200 mm bowl depth
- Fixing kit included
- Perimeter overflow
- Materic cover

Dimensions
 Cabinet 45 cm
 Ext dimension 456 x 456 mm
 Bowl dimension
 400 x 400 mm
 Bowl depth 200 mm

Accessories See page 62



Iseo 40 White

- Composit finishing
- 6 mm slim edge
- 200 mm bowl depth
- Fixing kit included
- Perimeter overflow
- Materic cover

Dimensions
 Cabinet 45 cm
 Ext dimension 456 x 456 mm
 Bowl dimension
 400 x 400 mm
 Bowl depth 200 mm

Accessories See page 62

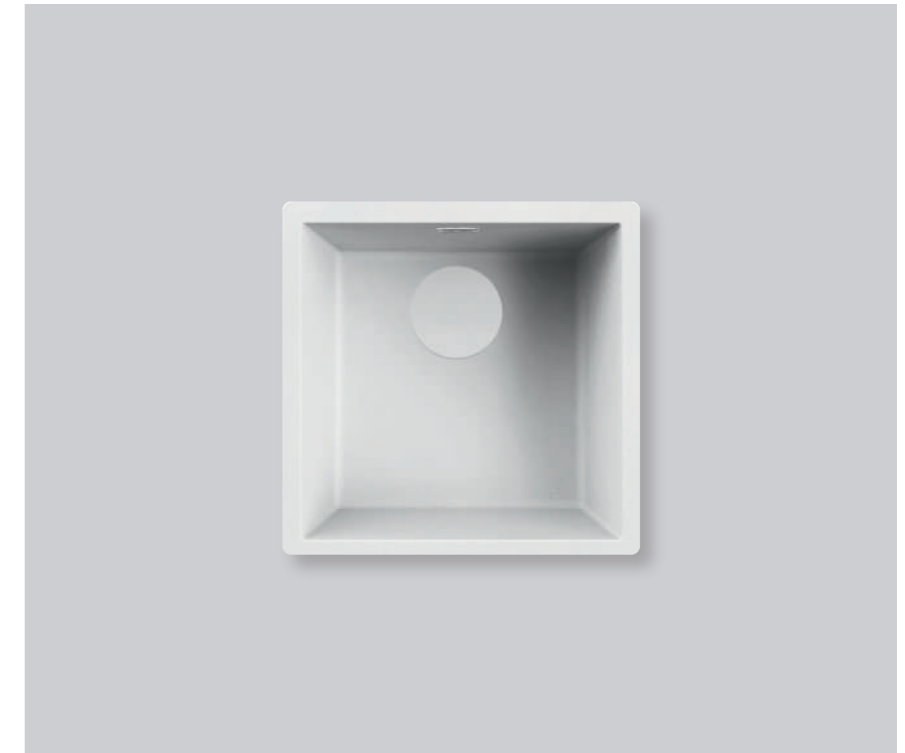

Technical Drawings

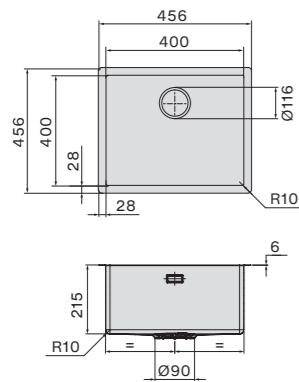

Codes and finishing

Type installation
 Code
 SIS4000F.00#CBF
 Finishing
 Composit material

Topmount

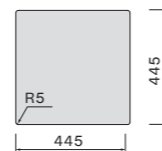

Type installation
 Code
 SIS4000F.00#CBF
 Finishing
 Composit material

Undermount

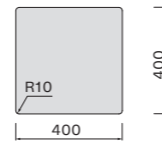

Suggested combinations



Technical Drawings

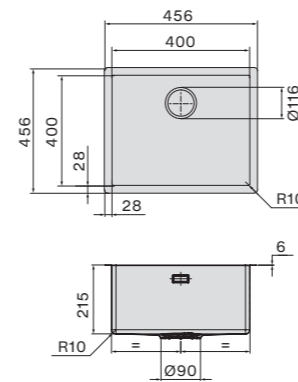

Codes and finishing

Type installation
 Code
 SIS4000F.00#CWF
 Finishing
 Composit material

Topmount

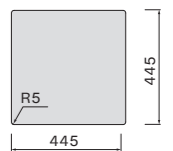

Type installation
 Code
 SIS4000F.00#CWF
 Finishing
 Composit material

Undermount

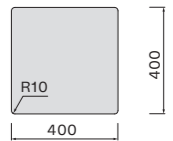

Suggested combinations



Iseo 50 Black

- Composit finishing
- 6 mm slim edge
- 200 mm bowl depth
- Fixing kit included
- Perimeter overflow
- Materic cover

Dimensions
 Cabinet 60 cm
 Ext dimension 556 x 456 mm
 Bowl dimension
 500 x 400 mm
 Bowl depth 200 mm

Accessories See page 62



Iseo 50 White

- Composit finishing
- 6 mm slim edge
- 200 mm bowl depth
- Fixing kit included
- Perimeter overflow
- Materic cover

Dimensions
 Cabinet 60 cm
 Ext dimension 556 x 456 mm
 Bowl dimension
 500 x 400 mm
 Bowl depth 200 mm

Accessories See page 62



Technical Drawings

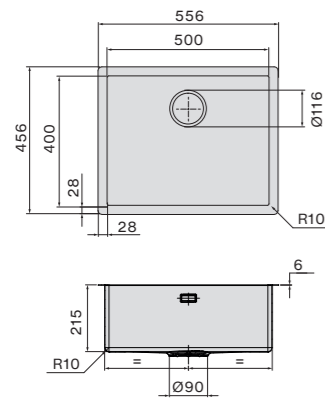

Codes and finishing

Type installation
 Code
 SIS5000F.00#CBF
 Finishing
 Composit material

Topmount

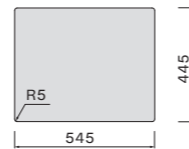

Type installation
 Code
 SIS5000F.00#CBF
 Finishing
 Composit material

Undermount

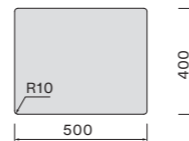

Suggested combinations

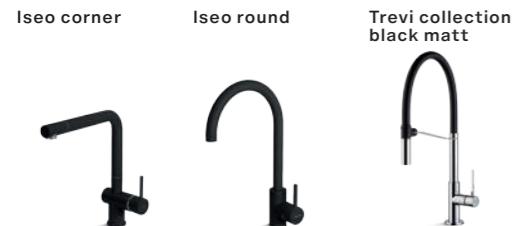

Technical Drawings

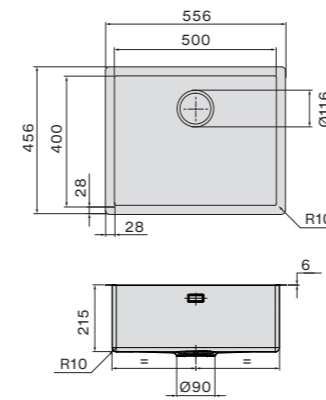

Codes and finishing

Type installation
 Code
 SIS5000F.00#CWF
 Finishing
 Composit material

Topmount

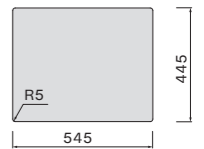

Type installation
 Code
 SIS5000F.00#CWF
 Finishing
 Composit material

Undermount

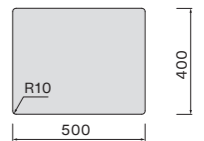

Suggested combinations



Iseo 70 Black

- Composit finishing
- 6 mm slim edge
- 200 mm bowl depth
- Fixing kit included
- Perimeter overflow
- Materic cover

Dimensions
 Cabinet 80 cm
 Ext dimension 756 x 456 mm
 Bowl dimension
 700 x 400 mm
 Bowl depth 200 mm

Accessories See page 62



Iseo 70 White

- Composit finishing
- 6 mm slim edge
- 200 mm bowl depth
- Fixing kit included
- Perimeter overflow
- Materic cover

Dimensions
 Cabinet 80 cm
 Ext dimension 756 x 456 mm
 Bowl dimension
 700 x 400 mm
 Bowl depth 200 mm

Accessories See page 62



Technical Drawings

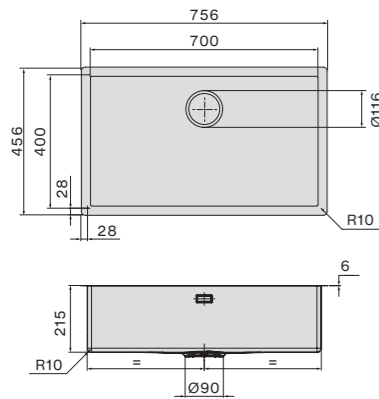

Codes and finishing

Type installation
 Code
 SIS7000F.00#CBF
 Finishing
 Composit material

Topmount

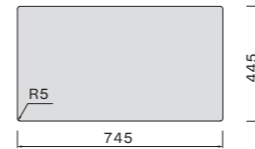

Type installation
 Code
 SIS7000F.00#CBF
 Finishing
 Composit material

Undermount

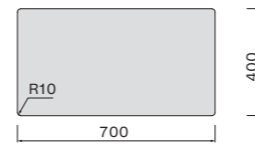

Suggested combinations



Technical Drawings

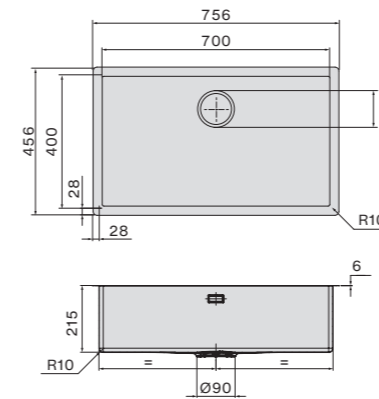

Codes and finishing

Type installation
 Code
 SIS7000F.00#CWF
 Finishing
 Composit material

Topmount

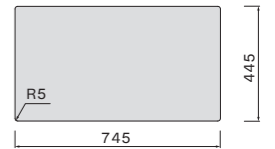

Type installation
 Code
 SIS7000F.00#CWF
 Finishing
 Composit material

Undermount

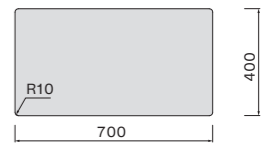

Suggested combinations





Taps and fittings

Falmec's excellence can be also appreciated in taps and fittings. A selection made with attention to each detail, to satisfy every stylistic and usage requirement, creating the most diverse and fascinating combinations with Falmec sinks and the most varied kitchen countertops.

Collection

- Trevi
- Pure Steel
- Iseo
- Easy

Pure steel

Pure Essence.

A collection of taps made entirely of AISI 304 steel, inspired by a concept of minimalist design and pure technicality, in tune with the daily needs of the domestic kitchen. A natural and totally recyclable element, steel integrates at his best with the Falmec world, perfectly matching the sinks and hoods made of this material.

Several versions are available, with stylistic features and characteristics designed to harmonize in many kitchen environments.



Hygienic,
corrosion
resistant and
easy to clean,
AISI 304 steel

expresses a
superior level of
quality in every
respect.





Pure steel



Pure steel flat		Pure steel round		Pure steel corner	
Single-lever sink mixer with flat swivel spout 3/8" female connection hoses.	Stainless Steel MPSF.00#SSF	Single-lever sink mixer with round swivel spout and pull out hand shower 3/8" female connection hoses.	Stainless Steel MPSP.00#SSF	Single-lever sink mixer with swivel spout and pull out hand shower 3/8" female connection hoses.	Stainless Steel MPSC.00#SSF

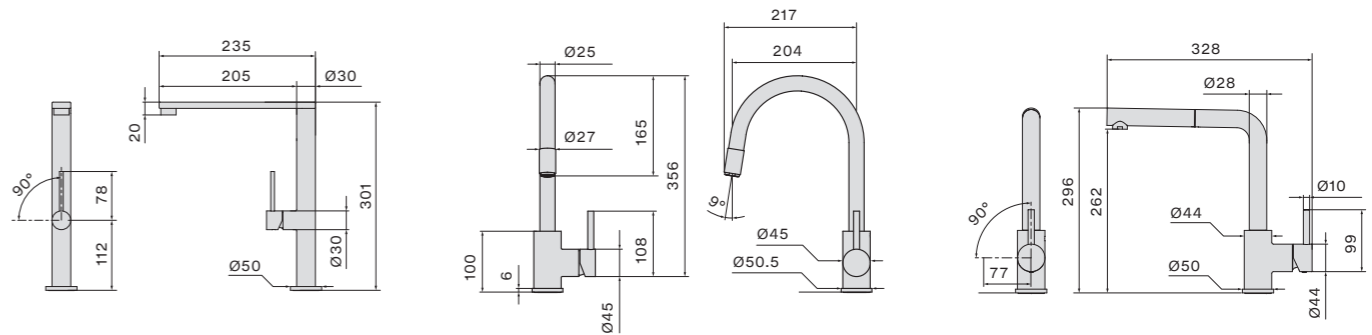

Trevi

Elegance and attention to detail.

This collection is characterized by slender and streamlined lines, where each detail is the subject of a precise stylistic and functional study.

A proposal that is articulated in various technical solutions, unique shapes and finishes, including the innovative PVD treatment that allows a perfect match with the sinks of the Como PVD Collection.

The choice ranges from the classic Round version, to the contemporary style of Corner, to the Trevi Pro model derived from the professional world.

All Trevi models are equipped with put-out shower to facilitate every washing activity in the kitchen.



With the PVD treatment, metal ions are attracted to the surface of the object, forming an extremely resistant coating.





Trevi



Trevi Round	Trevi Corner	Trevi Pro
Single-lever sink mixer with round swivel spout and pull out hand shower 3/8" female connection hoses.	Single-lever sink mixer with swivel spout and pull out hand shower 3/8" female connection hoses.	Single-lever sink mixer with swivel and adjustable spout 3/8" female connection hoses.
Chrome MTRR.00#CHF Matt black MTRR.00#MBF PVD Brushed Gunmetal MTRR.00#PPF PVD Brushed Copper MTRR.00#PQF PVD Brushed Gold MTRR.00#PGF	Chrome MTRC.00#CHF Matt black MTRC.00#MBF PVD Brushed Gunmetal MTRC.00#PPF PVD Brushed Copper MTRC.00#PQF PVD Brushed Gold MTRC.00#PGF	Chrome MTRP.00#CHF Matt black MTRP.00#MBF PVD Brushed Gunmetal MTRP.00#PPF PVD Brushed Copper MTRP.00#PQF PVD Brushed Gold MTRP.00#PGF

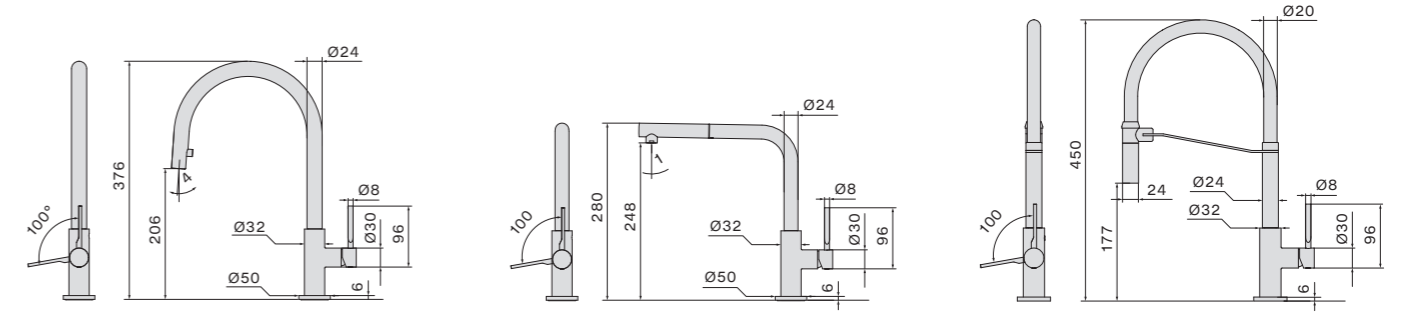

Chrome / Matt black / PVD Gunmetal / PVD Copper / PVD Gold





Iseo Corner

Single-lever sink mixer with swivel spout and retractable hand shower 3/8" female connection hoses.

Painted black
MISC.00#BLF
Painted white
MISC.00#WHF

Iseo Round

Single-lever sink mixer with swivel spout and retractable hand shower 3/8" female connection hoses.

Painted black
MISR.00#BLF
Painted white
MISR.00#WHF

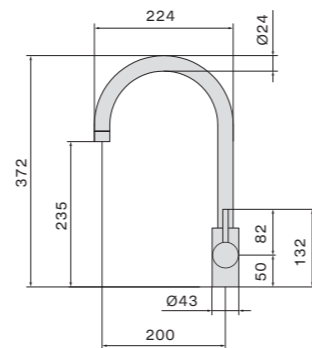
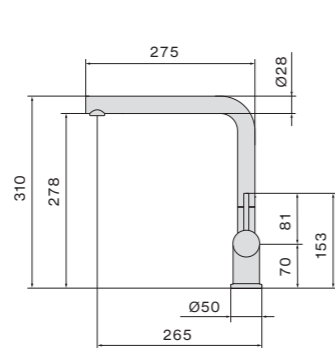

Easy Square

Single-lever sink mixer with tubular swivel spout 3/8" female connection hoses.

Chrome
MEAS.00#CHF

Easy Round

Single-lever sink mixer with tubular swivel spout 3/8" female connection hoses.

Chrome
MEAR.00#CH

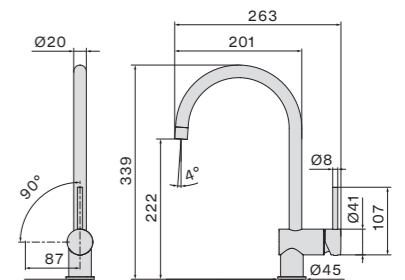
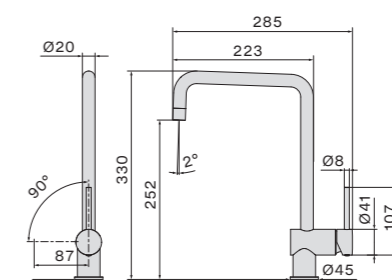



Optional and accessories

Washing, draining, cutting, preparing: with the optional extras and accessories tailor-made for the sinks of the Falmecc Water collection, every action in the kitchen is even easier, every sensation becomes even more pleasant and satisfying by transforming the washing area into a real food preparation station.

Optional and accessories



Iroko wood chopping board
Iroko wood chopping board 18 mm thickness.
Ext dimension: 330 x 420 mm



Polyethylene chopping board
Polyethylene chopping board 18 mm thickness
Ext dimension: 330 x 420 mm



Rollmat 440 Black Matt
Dimension (mm) 310 x 440 x 10
Avialable color Black



Automatic waste valve
Black Matt
White Matt
Chrome
Included in Garda Collection



Stainless steel soap dispenser
AISI 304 18/10
Stainless steel satin finish soap dispenser, tank capacity 250 ml. filling from above, it is not necessary to remove the tank.
The soap dispenser can be installed on any type of sink produced by Falmecc.



Stainless steel colander
AISI 304 18/10
Stainless steel colander 1 mm thickness.
Ext dimension: 200 x 440 mm
Int dimension: 155 x 390 mm
Depth: 100 mm



Stainless steel draining tray
AISI 304 18/10
Stainless steel draining tray 1 mm thickness.
Ext dimension: 200 x 440 mm
Int dimension: 155 x 390 mm
Depth: 30 mm



Stainless steel draining tray
AISI 304 18/10
Stainless steel draining tray 1 mm thickness.
Ext dimension: 370 x 440 mm
Int dimension: 325 x 390 mm
Depth: 30 mm

Installation and maintenance

The anti-corrosion properties of stainless steel decrease under the effect of acids and halogenated compounds (chloride, bromide, iodide). Never use chlorine-based solutions (e.g. bleach). Do not use corrosive substances (hydrogen chloride and acids in general) when cleaning the floor underneath the stainless steel product.

Avoid rust deposits caused by foreign materials, such as steel particles that come from other objects and not directly from the stainless steel product. For example, shavings and metallic powder residue from filing, sanding, drilling operations or the use of inappropriate cleaning instruments (for example, a steel wool pad).

Avoid storing the stainless steel product in a humid environment or near water in order to prevent rust formation.

Incipient rust can be caused by improper storage of the product prior to mounting.

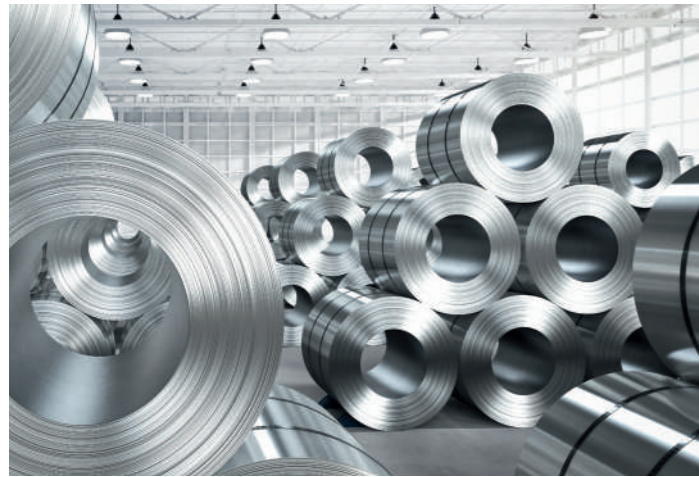

Clean the stainless steel parts daily with the following solutions:

- Water and vinegar (80% water and 20% vinegar)

- Lemon juice dissolved in water

- Non-corrosive and/or non-abrasive household cleansers that do not contain the substances mentioned above.

We recommend washing with warm water. Thoroughly rinse the stainless steel product and dry carefully.

During periods of long activity take the following precautions: vigorously rub all stainless steel surfaces with a cloth lightly soaked in Vaseline so as to create a protective film; air out the room after use.



Falmec S.p.A

via dell'Artigianato, 42 z.i.
31029 Vittorio Veneto
Treviso — Italy
info@falmec.com
falmec.com

Photos
Eye Studio/Fabio Cussigh

Styling
Eye Studio/Beppe Mangia

Graphic Design
Designwork

Texts editing
Daniele Varelli

*Post-production photos
and color separation*
Luce Group

Printed in Italy
©May 2022
Grafiche Antiga

